

35090

ShredMATIC®



DAHLE®

de	Originalgebrauchsanleitung.....	4
en	Instructions.....	7
fr	Mode d'emploi.....	10
es	Instrucciones.....	13
it	Istruzioni per l'uso.....	16
pt	Manual de instruções.....	19
nl	Gebruikershandleiding.....	22
da	Betjeningsvejledning.....	25
fi	Käyttöohje.....	28
no	Bruksanvisning.....	31
sv	Bruksanvisning.....	34
sl	Navodilo za uporabo.....	37
hr	Upute za uporabu.....	40
hu	Használati utasítás.....	43
ru	Инструкция по применению.....	46
et	Juhised.....	49
lt	Naudojimo instrukcija.....	52
lv	Lietošanas norādījumi.....	55
cs	Návod k použití.....	58
sk	Návod na použitie.....	61
pl	Instrukcja użytkowania.....	64
ro	Instrucțiuni de utilizare.....	67
bg	Указание за употреба.....	70
tr	Kullanım kılavuzu.....	73
el	Οδηγίες χρήσης.....	76
ar	تعليمات.....	79
ja	取扱説明書.....	82
zh	使用说明.....	85



de **Gebrauchsanleitung**



ACHTUNG!

Lesen Sie **VOR** Inbetriebnahme des Aktenvernichters die Gebrauchsanleitung und Sicherheitshinweise aufmerksam durch.



Die Hinweise müssen angewendet werden! Bewahren Sie die Gebrauchsanleitung für den späteren Gebrauch auf.

Inhaltsverzeichnis

1	Wichtige Informationen	4
1.1	Bestimmungsgemäße Verwendung, Gewährleistung	4
1.2	Sicherheitshinweise	5
1.3	Piktogrammlegende	5
1.4	Lieferumfang	88
1.5	Technische Daten	88
2	Bedienung	89
2.2	Gerät an das Stromnetz anschließen	89
2.3	Gerät einschalten	89
2.4	Papiervernichtung	90
2.10	Kartenvernichtung	92
3	Wartung / Störungsbeseitigung	93
3.1	Schnittgut entleeren	93
3.3	Behälter/Deckel offen	93
3.4	Überhitzung	94
3.6	Papierstau manueller Einzug	94
3.8	Papierstau automatischer Einzug	95
3.15	Gerät reinigen	97

1.1 **Bestimmungsgemäße Verwendung, Gewährleistung**

Der Aktenvernichter ist zum Vernichten von Papier bestimmt.

Je nach Modellvariante kann außerdem eine geringe Menge folgender Materialien vernichtet werden:

- CDs/DVDs, Scheck- und Kreditkarten (siehe Technische Daten).
- die in Papierdokumenten, in anwendungsüblichem Umfang, vorhandenen Heft- und Büroklammern (Ausnahme: Geräte der Sicherheitsstufe P6 und P7).

Verschleiß, Schäden durch unsachgemäßen Gebrauch, sowie Eingriffe von dritter Stelle, fallen weder unter die Gewährleistung noch unter die Garantie.

Der Aktenvernichter ist für den Betrieb im privaten Bereich und normaler Büroumgebung konzipiert.

Bzgl. der unter technische Daten angegebenen Blattleistung gelten folgende Rahmenbedingungen:
Maximale Anzahl von Blättern, die in einem Durchgang unter folgenden Bedingungen geschnitten werden:
Neue ggfs. geölte Schneidwalzen, kalter Motor, Stromversorgung mit Nennspannung und Nennfrequenz (230V/50Hz; 120V/60Hz).

Abweichungen können zu einer geringeren Blattleistung und zu erhöhten Laufgeräuschen führen.

Die Blätter werden mittig und längs unter 90° zugeführt. Je nach Papiereigenschaften und Zuführung kann die Blattleistung ebenfalls variieren.

1.2 Sicherheitshinweise

- Überprüfen Sie, dass die Spannung und Netzfrequenz Ihres Stromnetzes mit den Angaben auf dem Typenschild übereinstimmen.
- Das Gerät nicht in der Nähe einer Wärmequelle aufstellen!
- Das Gerät nur stehend lagern, transportieren und betreiben!
- Am Gerät nur Flüssigkeiten und Gase verwenden, welche den DAHLE-Richtlinien entsprechen!
- Das Gerät darf nicht geöffnet werden! Gefahr eines elektrischen Schlags!
- Das Gerät nur in geschlossenen Räumen, bei 10 °C bis 25 °C (50 °F bis 77 °F) und einer nichtkondensierenden Luftfeuchtigkeit von 15 % bis 94 % betreiben!
- Die Kurzschlussicherheit der Gebäudeinstallation ist sicherzustellen: max. 16A (US max. 20A).
- Das Gerät nicht im Leerlauf betreiben!
- Das Gerät ist nicht zur Benutzung von Personen bestimmt (einschließlich Kinder) mit eingeschränkten physischen, sensorischen oder geistigen Fähigkeiten oder mangelnder Erfahrung und Wissen, es sei denn, sie arbeiten unter Aufsicht oder erhalten eine ausführliche Anleitung zur Benutzung des Gerätes von einer Person die für die Sicherheit verantwortlich ist.



Entsorgen Sie den Aktenvernichter fach- und umweltgerecht bei einer autorisierten Sammelstelle. Geben Sie keine Teile des Aktenvernichters oder der Verpackung in den Hausmüll.

1.3 Piktogrammlegende

	Wichtige Information		Nicht in der Nähe von ätzenden Stoffen verwenden.		Berühren Sie die Papierzuführung nicht mit Kleidungsstücken!
	Gebrauchsanleitung/ Sicherheitshinweise lesen.		Das Gerät standsicher auf dem Boden und mit 100 mm Abstand zur Wand aufstellen, Stauwärme vermeiden, Feststellbremsen betätigen (Typenabhängig).		Berühren Sie die Papierzuführung nicht mit den Haaren!
	ACHTUNG		Nicht in der Nähe von brennbaren Flüssigkeiten oder Gasen verwenden.		Halten Sie Spraydosen fern!
	VORSICHT, Gefahr eines elektrischen Schlags.		Nicht in der Nähe von brennbaren Flüssigkeiten oder Gasen verwenden.		Büro- und Heftklammern vor dem Vernichtungsvorgang entfernen!
	ACHTUNG, bewegende Teile Diese Einrichtung ist nicht für die Benutzung durch Kinder vorgesehen, Berührung der Einführungsöffnung mit den Händen, der Kleidung oder den Haaren vermeiden. Stecker ziehen, wenn die Einrichtung längere Zeit nicht benutzt wird.		Automatischer Anlauf		Keine Disketten einführen!
	Nicht der Nässe aussetzen		Dieser Aktenvernichter ist nicht zur Benutzung durch Kinder bestimmt (das Produkt ist kein Spielzeug).		Vor Wartungsarbeiten den Aktenvernichter von der Stromversorgung trennen!
	ACHTUNG, scharfe Kanten. Nicht berühren.		Berühren Sie die Papierzuführung nicht mit den Händen.		Technische Daten - Technische Änderungen vorbehalten!
					Betriebslautstärke im Leerlauf



Einzugsgeschwindigkeit



Papier-Partikelschnitt



Karten-Partikelschnitt



Gewicht



Netzstecker dient als Trennvorrichtung der Stromversorgung.



Die Netzsteckdose muss jederzeit leicht zugänglich sein!



Bedienung



Aktenvernichter in Bereitschaft



Aktenvernichter in Betrieb



Automatische Abschaltung!



Bei längerem Betrieb und/oder Überlastung schaltet der Aktenvernichter automatisch zum Abkühlen ab.



Wartungshinweise / Störungsbeseitigung



Behälter voll



Mögliche Störungen



automatische Abschaltung bei offenem Gehäuse



en Instructions



IMPORTANT!

Read the operating and safety instructions **BEFORE** placing the document shredder into operation.



You must follow the instructions. Keep the operating instructions in a safe place ready for later use.

1.1 Intended use, warranty

The document shredder is intended to be used for shredding paper. Depending on the model variant, a small amount of the following materials can also be shredded:

- CDs/DVDs, bank cards and credit cards (see technical data).
- The normal staples and paper clips found in paper documents (exception: security level P6 and P7 devices).

Table of Contents

1	Important information	7
1.1	Intended use, warranty	7
1.2	Safety instructions	8
1.3	Key to pictograms	8
1.4	Scope of supply	88
1.5	Technical data	88
2	Operation	89
2.2	Connecting the device to the power supply	89
2.3	Switching on the device	89
2.4	Paper shredding	90
2.10	Card shredding	92
3	Maintenance/troubleshooting	93
3.1	Empty shredded waste	93
3.3	Container/cover open	93
3.4	Overheating	94
3.6	Paper jam, manual intake	94
3.8	Paper jam, automatic intake	95
3.15	Cleaning the device	97

Wear, damage due to improper use or unauthorised modifications and repairs are not covered by the warranty or the guarantee.

The document shredder was designed for private use and for use in normal office environments.

The following conditions apply to the performance in terms of sheets listed under technical data:

Maximum number of sheets that are shredded in one pass under the following conditions: New cutting rollers, oiled if needed, cold motor, power supply with nominal voltage and nominal frequency (230V/50 Hz; 120V/60 Hz).

Deviations may result in reduced sheet processing and increased operating noises. The sheets are fed centrally and lengthwise at a 90 degree angle. The performance in terms of sheets can also vary depending on the paper properties and input.

1.2 Safety instructions

- Check that the voltage and mains frequency of your electricity supply match the information on the name-plate.
- Do not place the device near a source of heat.
- Store, transport and operate the device in an upright position only.
- Only use liquids and gases on the device that comply with DAHLE guidelines.
- Do not open up the device. Risk of electric shock.
- Only operate the device in closed spaces, at temperatures of between 10°C and 25°C (50°F to 77°F) and at a non-condensing humidity of between 15% and 94%.
- Ensure that the building installation has short-circuit protection: max. 16A(US max. 20A).
- Do not operate the document shredder without inserting documents.
- The device is not intended for use by persons (including children) with restricted physical, sensory or mental capabilities or a lack of experience and knowledge, unless they are working under supervision or receive detailed instruction about how to use the device from a person who is responsible for safety.



Dispose of the document shredder properly in an environmentally friendly way at an authorised collection point. Do not dispose of any parts of the document shredder or packaging in domestic waste.

1.3 Key to pictograms



Important information



User information/safety instructions



WARNING



CAUTION! Risk of electric shock.



WARNING, moving parts
This equipment is not intended for use by children. Avoid touching the media feed opening with the hands, clothing or hair. Unplug this equipment when not in use for an extended period of time, hazardous moving parts in this equipment, keep body parts away from moving parts.



ATTENTION, sharp edges.
Do not touch.



Do not use near caustic substances.



Place the device in a stable position on the floor, leaving a gap of 100 mm to the wall, ensure no heat can accumulate, engage brake mechanisms (depending on type)



Do not use near inflammable liquids or gases.



Automatic start-up



Do not expose to moisture



This document shredder is not intended to be used by children (the product is not a toy).



Do not touch the paper feed with your hands.



Do not allow items of clothing to come into contact with the paper feed.



Do not allow your hair to come into contact with the paper feed.



Keep spray cans away from the device.



Remove paper clips and staples before shredding.





Do not insert any diskettes.





Disconnect the document shredder from the electrical power supply before performing maintenance work.

- 

Technical specifications
- Subject to technical modifications.
- 

The power plug is used to disconnect the power supply.
- 

The document shredder will switch off automatically to cool down if used for a long time and /or if overloaded
- 

Noise level when operated without shredding documents
- 

The mains socket must be easily accessible at all times.
- 

Maintenance instructions / troubleshooting
- 

How to use
- 

Container full
- 

Intake speed
- 

Document shredder on standby
- 

Possible malfunctions
- 

Paper - cross cut
- 

Document shredder in operation
- 

Automatic switch-off when housing is open
- 

Card - cross cut
- 

Automatic shut-down!
- 

Weight



fr Mode d'emploi



ATTENTION !

Lisez attentivement le mode d'emploi et les consignes de sécurité AVANT de mettre en marche le destructeur de documents !

Les consignes doivent être appliquées !

Conservez le mode d'emploi pour une utilisation ultérieure.



Sommaire

1	Informations importantes	10
1.1	Utilisation conforme, garantie	10
1.2	Consignes de sécurité	11
1.3	Légende des pictogrammes	11
1.4	Contenu de la livraison	88
1.5	Caractéristiques techniques	88
2	Utilisation	89
2.2	Connecter l'appareil au réseau électrique	89
2.3	Allumer l'appareil	89
2.4	Destruction de documents	90
2.10	Destruction de cartes	92
3	Entretien/dépannage	93
3.1	Vider le matériau découpé	93
3.3	Bac/couvercle ouvert	93
3.4	Surchauffe	94
3.6	Bourrage de papier introduction manuelle	94
3.8	Bourrage de papier introduction automatique	95
3.15	Nettoyer l'appareil	97

1.1 Utilisation conforme, garantie

Le destructeur de documents est destiné à détruire des documents papier. Selon le modèle, vous pouvez en outre utiliser l'appareil pour détruire les matériaux suivants en petite quantité:

- CD/DVD, cartes bancaires et de crédit (voir Caractéristiques techniques).
- Les agrafes et trombones présents dans les documents en papier, en quantités représentant une utilisation normale (exception : appareils de niveau de sécurité P6 et P7).

L'usure, les dommages dus à une utilisation incorrecte et les interventions de tierces personnes ne sont pas couvertes par la responsabilité du fabricant ni par la garantie.

Le destructeur de documents est conçu pour l'utilisation domestique et en environnement de bureau normal.

En ce qui concerne la capacité de feuilles mentionnée dans les caractéristiques techniques, les conditions cadres suivantes sont applicables:

Nombre maximum de feuilles pouvant être découpées en un passage dans les conditions suivantes: Rouleaux de coupe neufs, huilés le cas échéant, moteur froid, alimentation avec tension et fréquence nominales (230V/50 Hz ; 120V/60 Hz).

Des divergences peuvent entraîner une capacité de feuilles réduite et des émissions sonores accrues. Les feuilles sont introduites au centre et en longueur à un angle inférieur à 90°. La capacité de feuilles peut également varier selon les caractéristiques du papier et l'introduction.





















1.2 Consignes de sécurité

















- Vérifiez que la tension et la fréquence de votre réseau électrique correspondent aux indications figurant sur la plaque signalétique.
- Ne pas installer l'appareil à proximité d'une source de chaleur !
- Ranger, transporter ou utiliser l'appareil en position verticale uniquement !
- Utiliser à proximité de l'appareil uniquement des liquides et des gaz conformes aux directives DAHLE !
- Il est interdit d'ouvrir l'appareil ! Risque de choc électrique !
- Utiliser l'appareil dans des locaux fermés uniquement, à des températures comprises entre 10 °C et 25 °C (entre 50 °F et 77 °F) et une hygrométrie non condensée comprise entre 15 % et 94 % !
- L'installation électrique du bâtiment doit être protégée contre les courts-circuits 16 Amax. (20 Amax. aux USA).
- Ne pas laisser l'appareil tourner à vide !
- L'appareil n'est pas destiné à une utilisation par des personnes (y compris les enfants) aux capacités physiques, sensorielles ou mentales diminuées ou ne disposant pas de l'expérience et du savoir nécessaire, à moins que celles-ci soient sous surveillance ou qu'elles reçoivent des consignes exhaustives concernant l'utilisation de l'appareil de la part d'une personne responsable de la sécurité.



Éliminez le destructeur de documents dans le respect des règles et de l'environnement dans un point de collecte autorisé. Ne jetez pas de composants du destructeur de documents ou de l'emballage dans les ordures ménagères.

1.3 Légende des pictogrammes

- | | | |
|---|--|--|
|  Information importante |  Placer l'appareil au sol de manière à ce qu'il soit bien stable et à une distance de 100 mm du mur, éviter la chaleur stagnante, actionner les freins de blocage (selon le modèle) |  Ne touchez pas le dispositif d'alimentation du papier avec vos vêtements ! |
|  Lire les informations pour l'utilisateur/consignes de sécurité |  Ne pas utiliser l'appareil à proximité de liquides ou de gaz inflammables. |  Ne touchez pas le dispositif d'alimentation du papier avec vos cheveux ! |
|  ATTENTION |  Ne pas utiliser l'appareil à proximité de liquides ou de gaz inflammables. |  Tenez les bombes aérosols à l'écart ! |
|  ATTENTION! Risque de choc électrique. |  Démarrage automatique |  Retirer les trombones et les agrafes des documents avant de les détruire ! |
|  ATTENTION, pièces mobiles |  Ne pas exposer l'appareil à l'humidité. |  Ne pas introduire de disquettes ! |
|  ATTENTION, arêtes vives |  Ce destructeur de documents n'est pas destiné à être utilisé par des enfants (le produit n'est pas un jouet). |  Débrancher le destructeur de documents de l'alimentation électrique avant de procéder aux opérations d'entretien ! |
|  Ne pas utiliser l'appareil à proximité de substances corrosives. |  Ne touchez pas le dispositif d'alimentation du papier avec les mains. |  Caractéristiques techniques - Sous réserve de modifications techniques ! |

- | | | | | | |
|--|--|---|--|---|---|
|  | Volume sonore à vide |  | La prise de courant doit toujours être aisément accessible ! |  | Le destructeur de documents s'éteint automatiquement après une utilisation prolongée et/ou en cas de surcharge afin de refroidir. |
|  | Vitesse d'introduction |  | Utilisation |  | Consignes d'entretien/
Dépannage |
|  | Papier - coupe croisée (particules) |  | Destructeur de documents en veille |  | Bac plein |
|  | Cartes - coupe croisée (particules) |  | Destructeur de documents en marche |  | Problèmes possibles |
|  | Poids |  | Arrêt automatique ! |  | Arrêt automatique en cas de boîtier ouvert |
|  | La prise sert de dispositif de sectionnement de l'alimentation électrique. | | | | |

es Instrucciones



ATENCIÓN:

Lea detenidamente las instrucciones de uso y las indicaciones sobre seguridad antes de poner en marcha la destructora. Deben cumplirse todas las indicaciones.



Guarde el manual de instrucciones por si lo necesita en otro momento.

1.1 Utilización conforme al uso prescrito, garantía

La destructora está destinada a triturar papel. Según la variante del modelo, se puede triturar además una pequeña cantidad de los siguientes materiales:

- CDs/DVDs, tarjetas bancarias y tarjetas de crédito (véase Datos técnicos).
- Los clips y grapas que lleven los documentos en papel, dentro de los límites del uso habitual (excepción: equipos de nivel de seguridad P6 y P7).

La garantía no cubre el desgaste, los daños causados por uso indebido ni las consecuencias de una manipulación por parte de terceros.

La destructora está pensada para su uso por particulares y en entornos normales de oficina.

Los datos técnicos relativos a la alimentación de papel están sujetos a las siguientes condiciones:
Cantidad máxima de hojas cortadas de una vez en las siguientes condiciones: Tambor de corte nuevo y engrasado (si procede), motor en frío, corriente eléctrica con tensión y frecuencia nominal (230V/50Hz; 120V/60Hz).

Las variaciones pueden repercutir en una reducción de la alimentación de papel y en un aumento de los ruidos de funcionamiento. Las hojas se deben introducir centradas y a lo largo a 90°. La capacidad de alimentación del papel también puede variar dependiendo de las características del papel y el modo de introducirlo.

Índice

1	Información importante	13
1.1	Utilización conforme al uso prescrito, garantía	13
1.2	Indicaciones de seguridad	14
1.3	Significado de los pictogramas	14
1.4	Contenido de suministro	88
1.5	Datos técnicos	88
2	Manejo	89
2.2	Conectar el aparato a la red eléctrica	89
2.3	Encender el aparato	89
2.4	Destrucción de papel	90
2.10	Destrucción de tarjetas	92
3	Mantenimiento/Resolución de problemas	93
3.1	Vaciado del contenedor	93
3.3	Contenedor abierto/tapa abierta	93
3.4	Sobrecalentado	94
3.6	Atasco con alimentación de papel manual	94
3.8	Atasco con alimentación de papel automática	95
3.15	Limpieza del aparato	97

1.2 Indicaciones de seguridad

- Compruebe que la tensión y la frecuencia de red de su red eléctrica coincide con las indicaciones de la placa de características.
- No colocar el aparato cerca de ninguna fuente de calor.
- Almacenar, transportar y utilizar el aparato exclusivamente en posición vertical.
- Aplicar a la destructora exclusivamente líquidos y gases que cumplan las especificaciones de DAHLE.
- No abrir el aparato! Riesgo de shock eléctrico!
- Utilizar el aparato exclusivamente en lugares cerrados, a una temperatura entre 10°C y 25°C (entre 50°F y 77°F) y con una humedad ambiental no condensante entre el 15% y el 94%.
- La instalación eléctrica del edificio deberá estar protegida contra cortocircuitos: máx. 16A(para EE.UU. máx. 20A).
- El aparato nunca debe funcionar en vacío.
- Este aparato no está destinado a su uso por parte de personas (incluidos niños) con facultades físicas, sensoriales o mentales reducidas o con falta de experiencia y conocimiento, salvo que lo utilicen bajo la supervisión de una persona que se responsabilice de la seguridad o esta les haya instruido de forma detallada en el manejo del aparato.



Desechar la destructora debidamente en un punto limpio autorizado y cumpliendo la normativa medioambiental. No deseche ninguna parte de la destructora ni del embalaje con la basura doméstica.

1.3 Significado de los pictogramas



Información importante



Leer atentamente la información para el usuario y las indicaciones de seguridad



Colocar el aparato en el suelo y en posición vertical estable, a una distancia de 100 mm de la pared, evitando que se acumule el calor, accionar los frenos inmovilizadores (en determinados modelos)



Evitar que la ropa entre en contacto con el alimentador de papel.



No aproximar el cabello al alimentador de papel.



ATENCIÓN



No aproximar botes de spray.



Precaución! Riesgo de shock eléctrico.



No utilizar cerca de líquidos o gases inflamables.



Antes de destruir papel, retirar todos los clips y grapas que pueda llevar.



ATENCIÓN, partes móviles



Inicio automático



No introducir disquetes.



ATENCIÓN, bordes afilados



Evitar que el aparato se moje.



Antes de realizar cualquier trabajo de mantenimiento, desconectar la destructora de la red eléctrica.



No utilizar cerca de sustancias corrosivas.



Esta destructora no está destinada para ser utilizada por niños (este producto no es un juguete).



Datos técnicos - ¡Sujeto a modificaciones técnicas sin previo aviso!



No tocar el alimentador de papel.



Emisión de ruido durante el funcionamiento



El enchufe debe estar fácilmente accesible en todo momento.



Consejos de mantenimiento y resolución de problemas



Velocidad de inserción



Manejo



Depósito lleno



Papel - corte en partículas



Destructora lista para ser utilizada



Posibles averías



Tarjetas - corte en partículas



Destructora en funcionamiento



El aparato se desconecta automáticamente cuando se abre la carcasa.



Peso



Desconexión automática.



La clavija de red actúa como dispositivo desconector de la alimentación eléctrica.



En caso de sobrecarga o de un uso excesivo, la destructora se apaga automáticamente para enfriarse.



it Istruzioni per l'uso



ATTENZIONE!

PRIMA della messa in funzione della distruggidocumenti, leggere attentamente il manuale d'uso e le istruzioni di sicurezza. Le istruzioni devono essere applicate!



Conservare il manuale d'uso per l'utilizzo successivo.

Indice

1	Informazioni importanti	16
1.1	Utilizzo conforme, garanzia	16
1.2	Istruzioni di sicurezza	17
1.3	Legenda pittogrammi	17
1.4	Oggetto della fornitura	88
1.5	Dati tecnici	88
2	Uso	89
2.2	Collegare l'apparecchio alla rete della linea elettrica	89
2.3	Accendere l'apparecchio	89
2.4	Distruzione della carta	90
2.10	Distruzione di carte	92
3	Manutenzione/Riparazione	93
3.1	Eliminare il materiale triturato	93
3.3	Contenitore/coperchio aperto	93
3.4	Surriscaldamento	94
3.6	Inceppamento carta caricamento manuale	94
3.8	Inceppamento carta caricamento automatico	95
3.15	Pulizia dell'apparecchio	97

1.1 Utilizzo conforme, garanzia

Il distruggi documenti è destinato alla distruzione di carta.

A seconda del modello è inoltre possibile distruggere una piccola quantità dei seguenti materiali:

- CD/DVD, carte assegni e carte di credito (vedere dati tecnici).
- Le graffette e i punti metallici comunemente utilizzati per fascicolare i documenti di carta (eccezione: apparecchi di livello di sicurezza P6 e P7).

La garanzia non comprende l'usura, i danni da utilizzo non conforme nonché gli interventi da parte di terzi.

Il distruggi documenti è concepito per l'utilizzo privato o per il normale utilizzo d'ufficio.

La portata di fogli riportata nei dati tecnici è soggetta alle seguenti condizioni generali:

Numero massimo di fogli tagliati per volta nelle seguenti condizioni: rulli da taglio nuovi o lubrificati, motore freddo, alimentazione con tensione nominale e frequenza nominale (230V/50Hz; 120V/60Hz).

Condizioni diverse da quelle indicate possono comportare una portata di fogli inferiore e un aumento del rumore generato dal dispositivo in funzione. I fogli vanno inseriti al centro e per il lungo con un'inclinazione inferiore a 90°. La portata di fogli può variare a seconda delle proprietà della carta e dell'inserimento.

1.2 Istruzioni di sicurezza

- Verificare che la tensione e la frequenza di rete siano conformi ai dati riportati sulla targhetta identificativa.
- Non posizionare l'apparecchio in prossimità di fonti di calore!
- Utilizzare, riporre e trasportare l'apparecchio esclusivamente in posizione verticale!
- Sull'apparecchio utilizzare solo sostanze liquide o gassose conformi alle direttive DAHLE!
- Non aprire l'apparecchio! Rischio di scossa elettrica!
- È necessario garantire che l'impianto dell'edificio sia protetto da cortocircuiti: max. 16A (US massimo 20A).
- Utilizzare l'apparecchio solo in ambienti chiusi, a temperature comprese tra i 10°C e i 25°C (da 50°F a 77°F) e con un'umidità dell'aria senza condensa tra il 15% e il 94%!
- Non utilizzare l'apparecchio a vuoto!
- L'apparecchio non è adatto all'utilizzo da parte di persone con ridotte capacità fisiche, sensoriali o mentali (inclusi i bambini), oppure prive della necessaria esperienza o conoscenza, a meno che non lavorino sotto sorveglianza o che ricevano istruzioni dettagliate circa l'utilizzo dell'apparecchio da una persona responsabile della sicurezza.



La distruggidocumenti deve essere smaltita in conformità con le norme vigenti in materia di tutela dell'ambiente presso un centro di raccolta autorizzato. Non gettare alcun componente della distruggidocumenti o dell'imballaggio nei rifiuti domestici.

1.3 Leggenda pittogramma

	Informazioni importanti		Posizionare l'apparecchio sul pavimento e a una distanza di 100 mm dalla parete, evitare ristagni di calore, azionare i freni di blocco (a seconda del modello)		Assicurarsi che gli abiti non tocchino l'alimentatore della carta!
	Leggere le informazioni utente e le istruzioni di sicurezza		Non utilizzare in prossimità di liquidi o gas infiammabili.		Non toccare l'alimentatore della carta con i capelli!
	ATTENZIONE		Non utilizzare in prossimità di liquidi o gas infiammabili.		Tenere lontano da bombolette spray!
	ATTENZIONE! Rischio di scossa elettrica.		Avvio automatico		Prima di distruggere i documenti, rimuovere punti e graffette!
	ATTENZIONE, parti in movimento		Non esporre all'umidità		Non inserire dischetti!
	ATTENZIONE, spigoli vivi		L'apparecchio non è destinato all'uso da parte dei bambini (il prodotto non è un giocattolo).		Prima degli interventi di manutenzione, staccare la presa della distruggidocumenti!
	Non utilizzare in prossimità di sostanze corrosive.		Non toccare l'alimentatore della carta con le mani.		Dati tecnici – Si riserva la facoltà di apportare modifiche tecniche!

- | | | |
|--|--|--|
|  <p>Rumorosità in esercizio a vuoto</p> |  <p>La presa di corrente deve essere sempre facilmente accessibile!</p> |  <p>Dopo un periodo di esercizio prolungato e/o sovraccarico la distruggidocumenti si spegne automaticamente per garantire il raffreddamento.</p> |
|  <p>Velocità di inserimento</p> |  <p>Utilizzo</p> | |
|  <p>Taglio carta a particelle</p> |  <p>Distruggidocumenti in standby</p> |  <p>Istruzioni per la manutenzione/Risoluzione delle anomalie</p> |
|  <p>Taglio carte plastificate a particelle</p> |  <p>Distruggidocumenti in esercizio</p> |  <p>Recipiente pieno</p> |
|  <p>Peso</p> |  <p>Spegnimento automatico!</p> |  <p>Possibili guasti/anomalie</p> |
|  <p>La spina funge da separatore dell'alimentazione di corrente.</p> | |  <p>Spegnimento automatico in caso di cassetto aperto</p> |

pt Manual de instruções



ATENÇÃO!

ANTES de colocar a trituradora de papel funcionamento, ler cuidadosamente o manual de utilização e as indicações de segurança.



**As indicações devem ser respeitadas!
Guarde o manual de utilização para uso futuro.**

Índice

1	Informações importantes.....	19
1.1	Utilização correta, garantia.....	19
1.2	Indicações de segurança.....	20
1.3	Legenda dos pictogramas.....	20
1.4	Âmbito de fornecimento.....	88
1.5	Dados técnicos.....	88
2	Operação.....	89
2.2	Ligar o aparelho à rede elétrica.....	89
2.3	Ligar o aparelho.....	89
2.4	Trituração de papel.....	90
2.10	Trituração de cartões.....	92
3	Manutenção/resolução de problemas.....	93
3.1	Esvaziar os resíduos de papel.....	93
3.3	Recipiente/tampa aberta.....	93
3.4	Sobreaquecimento.....	94
3.6	Acumulação de papel na introdução manual ...	94
3.8	Acumulação de papel na introdução automática.....	95
3.15	Limpar o aparelho.....	97

1.1 Utilização correta, garantia

A trituradora de papel destina-se à trituração de papel. Conforme a variante do modelo podem ser eliminados os seguintes materiais em quantidades reduzidas:

- CDs/DVDs, cartões de crédito e de cheque (ver dados técnicos).
- Clipes e agramos que estejam presentes, em quantidades normais, nos documentos de papel (exceção: aparelhos com nível de segurança P6 e P7).

Desgaste, danos provocados por uma utilização incorreta, assim como intervenções de terceiros não estão abrangidos pela garantia, nem o fabricante assume qualquer responsabilidade pelos mesmos.

A trituradora de papel foi concebida para uso doméstico e para o funcionamento num ambiente de escritório normal.

No que se refere ao desempenho das folhas indicado nos dados técnicos, aplicam-se as seguintes condições básicas:

Número máximo de folhas cortadas de uma só vez, segundo as seguintes condições de funcionamento: Rolamentos de corte novos ou possivelmente oleados, motor frio, fonte de alimentação com tensão nominal e frequência nominal (230V/50Hz; 120V/60Hz).

O não cumprimento destas condições de funcionamento pode levar ao desempenho reduzido da lâmina e ao aumento de ruídos de funcionamento. As folhas devem ser introduzidas centralmente e longitudinalmente a 90°. As propriedades do papel e da sua forma de introdução também podem alterar o desempenho das folhas.



1.2 Indicações de segurança

















- Verificar se a tensão e a frequência de rede da sua rede de corrente correspondem às indicações da placa de identificação.
 - Não colocar o aparelho perto de uma fonte de calor!
 - Armazenar, transportar ou utilizar o aparelho exclusivamente na vertical!
 - Utilizar no aparelho apenas líquidos e gases que correspondam às diretivas DAHLE!
 - Não abrir o aparelho!
 - O aparelho deve ser operado exclusivamente em espaços fechados, a uma temperatura entre os 10 °C e os 25 °C (50 °F e 77 °F) e uma humidade atmosférica não condensada de 15 % a 94 %!
 - Providenciar a proteção contra curto-circuito na instalação dos edifícios: máx. 16 A (EUA: máx. 20 A).
 - Não utilizar o aparelho em vazio!
- Este aparelho não é indicado para utilização por pessoas (incluindo crianças) com capacidades físicas, sensoriais ou mentais reduzidas ou com pouca experiência e conhecimento, exceto se forem supervisionadas durante o trabalho ou receberem instruções relativamente à utilização do aparelho por uma pessoa responsável pela sua segurança.



Elimine a trituradora de papel de forma adequada e compatível com o meio ambiente num ponto de recolha automatizado. Não coloque nenhuma peça da trituradora de papel ou a embalagem no lixo doméstico.

1.3 Legenda dos pictogramas

	Informações importantes		Pousar o aparelho de forma estável no chão e com uma distância de 100 mm da parede. Evitar a acumulação de calor. Acionar os travões de fixação (consoante o modelo)		Não toque com a roupa na alimentação do papel!
	Ler as informações ao utilizador/indicações de segurança				Não toque com os cabelos na alimentação do papel!
	ATENÇÃO		Não utilizar junto de líquidos ou gases inflamáveis.		Mantenha latas de aerossol afastadas do dispositivo!
	ATENÇÃO! Risco de choque elétrico.		Iniciação automática		Remover agramos e cliques antes do processo de trituração!
	ATENÇÃO, peças móveis		Não expor à humidade.		Não inserir disquetes!
	ATENÇÃO, arestas vivas		Esta trituradora de papel não se destina a ser utilizada por crianças (o produto não é nenhum brinquedo).		Antes dos trabalhos de manutenção, desligar a trituradora de papel da rede elétrica!
	Não utilizar junto de materiais ácidos.		Não toque com as mãos na alimentação do papel.		Dados técnicos – Sujeito a alterações técnicas!

- | | | | | | |
|--|---|---|---|---|---|
|  | Volume de funcionamento em vazio |  | A tomada de rede deve estar sempre acessível! |  | Indicações de manutenção/ eliminação de avarias |
|  | Velocidade de recolhimento |  | Operação |  | Recipiente cheio |
|  | Papel - corte em partículas |  | Trituradora de papel operacional |  | Possíveis avarias |
|  | Cartão - corte em partículas |  | Trituradora de papel em funcionamento |  | Desativação automática no caso de abertura da caixa |
|  | Peso |  | Desativação automática! | | |
|  | A ficha serve de dispositivo separador da alimentação de energia. |  | Após um funcionamento prolongado e/ou sobrecarga, a trituradora de papel desliga-se automaticamente para arrefecer. | | |

nl Gebruikershandleiding



OPGELET!

VOOR u de papiervernietiger gebruikt, moet u aandachtig de handleiding en veiligheidsaanwijzingen lezen!



Volg alle veiligheidsvoorschriften!
Bewaar de handleiding voor later gebruik.

Inhoudsopgave

1	Belangrijke informatie.....	22
1.1	Bedoeld gebruik, garantieaanspraak.....	22
1.2	Veiligheidsaanwijzingen.....	23
1.3	Legenda van pictogrammen.....	23
1.4	Leveringsomvang.....	88
1.5	Technische gegevens.....	88
2	Bediening.....	89
2.2	Apparaat op het stroomnet aansluiten.....	89
2.3	Apparaat inschakelen.....	89
2.4	Papiervernietiging.....	90
2.10	Kaartvernietiging.....	92
3	Onderhoud/probleemoplossing.....	93
3.1	Versnipperd materiaal verwijderen.....	93
3.3	Opvangbak/deksel open.....	93
3.4	Oververhitting.....	94
3.6	Papierverstopping manuele toevoer.....	94
3.8	Papierverstopping automatische toevoer.....	95
3.15	Apparaat reinigen.....	97

1.1 Bedoeld gebruik, garantieaanspraak

De papiervernietiger is bedoeld voor het versnipperen van papier. Afhankelijk van de modelvariant kunnen naast papier ook kleine hoeveelheden van de volgende materialen worden vernietigd:

- cd's/dvd's, betaalpasjes en creditcards (zie Technische gegevens).
- In papieren documenten aanwezige nietjes en paperclips (uitzondering: apparaten met veiligheidsniveau P6 en P7).

Slijtage of schade door onjuist gebruik vallen net als ingrepen van derden noch onder de garantieaanspraak, noch onder de garantie.

De papiervernietiger is ontworpen voor privé gebruik en normaal gebruik in een kantooromgeving.

De volgende voorwaarden zijn van toepassing op de prestaties van het vel gespecificeerd onder technische gegevens:

Maximumaantal vellen in één keer gesneden onder de volgende omstandigheden: Nieuwe of geoliede snijrollen, koude motor, voeding met nominale spanning en nominale frequentie (230V/50Hz, 120V/60Hz).

Afwijkingen kunnen leiden tot lagere prestaties en meer geluid. De vellen worden in het midden en in de lengte onder 90° ingevoerd. Afhankelijk van de papiereigenschappen en invoer, kan de veluitvoer ook variëren.

1.2 Veiligheidsaanwijzingen

- Controleer of de spanning en stroomfrequentie van uw stroomnetwerk overeenkomen met de gegevens op het typeplaatje.
- Het apparaat niet in de nabijheid van warmtebronnen opstellen!
- Het apparaat uitsluitend rechtop staand bewaren, transporteren en gebruiken!
- Gebruik voor het apparaat uitsluitend vloeistoffen en gassen die aan de DAHLE-richtlijnen voldoen!
- Het apparaat mag niet worden geopend!
- Het apparaat alleen gebruiken in gesloten ruimtes met een omgevingstemperatuur van 10 °C tot 25 °C (50 °F tot 77 °F) en een niet-condenserende luchtvochtigheid van 15 % tot 94 %!
- Er moet een kortsluitingszekering in de elektrische installatie van het gebouw aanwezig zijn van max. 16 A (VS 20 A).
- Het apparaat niet leeg gebruiken!
- Het apparaat is niet bedoeld voor gebruik door personen (inclusief kinderen) met verminderde lichamelijke, zintuiglijke of verstandelijke vermogens of gebrek aan ervaring en kennis, tenzij ze werken onder toezicht of instructies krijgen over het gebruik van het apparaat door een persoon die verantwoordelijk is voor de veiligheid.



Lever voor een milieuvriendelijke en vakkundige afvalverwerking de papiervernietiger in bij een bevoegd verwerkingsbedrijf. Zet geen delen van de papiervernietiger of het verpakingsmateriaal bij het huisvuil.

1.3 Legende van pictogrammen

- | | | | | | |
|--|--|--|--|--|---|
| | Belangrijke informatie | | Zet het apparaat op een stabiele ondergrond op minstens 10 cm van de muur. Voorkom warmteaccumulatie. Vastzetremmen gebruiken (modelafhankelijk) | | Raak de papierinvoeropening niet aan met uw handen. |
| | Gebruikersinformatie/veiligheidsaanwijzingen lezen | | Niet gebruiken in de nabijheid van ontvlambare vloeistoffen of gassen. | | Houd kledingstukken uit de buurt van de papierinvoeropening! |
| | Waarschuwing | | Automatische start | | Blijf met uw haar uit de nabijheid van de papierinvoeropening! |
| | AANDACHT! Risico op elektrische schokken. | | Automatische start | | Houd spuitbussen uit de buurt van de papiervernietiger! |
| | VOORZICHTIG, bewegende onderdelen | | Niet aan vochtigheid blootstellen. | | Voor men papier versnipperet, moet men paperclips en nietjes verwijderen! |
| | VOORZICHTIG, scherpe randen | | Deze papiervernietiger is niet bedoeld voor gebruik door kinderen (dit product is geen speelgoed). | | Geen diskettes invoeren! |
| | Niet gebruiken in de nabijheid van agressieve stoffen. | | | | |



Alvorens onderhoudswerkzaamheden aan de papiervernietiger uit te voeren, moet men de stekker uit het stopcontact halen!



Technische gegevens - technische wijzigingen onder voorbehoud!



Werkingsgeluidsterkte bij onbelast gebruik



Doorvoersnelheid



Papier - deeltjessnit



Kaarten - deeltjessnit



Gewicht



De stroomstekker dient als ontkoppelinrichting van de stroomvoorziening.



Het stopcontact moet op elk moment gemakkelijk toegankelijk zijn!



Bediening



Papiervernietiger gereed



Papiervernietiger in bedrijf



Automatische uitschakeling!



Bij langdurig gebruik en/of overbelasting wordt de papiervernietiger voor afkoeling automatisch uitgeschakeld.



Onderhoudsaanwijzingen/storingen verhelpen



Opvangbak vol



Mogelijke storingen



Automatische uitschakeling bij open behuizing

da Betjeningsvejledning



GIV AGT!

Læs betjeningsvejledningen og sikkerhedsanvisningerne til makulatoren nøje, FØR den tages i brug.



Anvisningerne skal følges!

Opbevar betjeningsvejledningen til senere anvendelse.

Indholdsfortegnelse

1	Vigtige oplysninger.....	25
1.1	Tilsigtet anvendelse, garanti.....	25
1.2	Sikkerhedsanvisninger.....	26
1.3	Forklaring af symboler.....	26
1.4	Pakkens indhold.....	88
1.5	Tekniske data.....	88
2	Betjening.....	89
2.2	Tilslutning til strømforsyningsnettet.....	89
2.3	Tænde apparatet.....	89
2.4	Papirmakulering.....	90
2.10	Kortmakulering.....	92
3	Vedligeholdelse/fejlfhjælpning.....	93
3.1	Tømning.....	93
3.3	Beholder/dæksel åben.....	93
3.4	Overophedning.....	94
3.6	Papirblokering – manuel indtrækning.....	94
3.8	Papirblokering – automatisk indtrækning.....	95
3.15	Renholdelse.....	97

1.1 Tilsigtet anvendelse, garanti

Makulatoren er beregnet til makulering af papir.

Alt efter model og variant kan der desuden makuleres små mængder af følgende materialer:

- cd'er/dvd'er, check- og kreditkort (se tekniske data).
- hæfteklammer og papirclips i papirdokumenter, i normalt omfang (undtagelse: apparater på sikkerhedsniveau P6 og P7).

Slid, beskadigelse på grund af forkert anvendelse samt indgreb udført af tredjepart er hverken omfattet af garantien eller producentens hæftelse.

Makulatoren er beregnet til privat brug og i et normalt kontormiljø.

Følgende rammebetingelser er gældende for det maksimale antal ark, der er angivet i de tekniske data: Maksimalt antal ark, der kan makuleres på én gang under følgende betingelser: Nye eller smurte skærevalser, kold motor, strømforsyning med mærkespænding og mærkefrekvens (230V/50Hz; 120V/60Hz).

Afvigelser kan medføre, at der kan makuleres et mindre antal ark og et forhøjet støjniveau under makuleringen. Arkene tilføres midt i spalten og på langs under 90°. Antallet af ark, der kan makuleres, kan også variere, alt efter papirets egenskaber og tilføringen.

1.2 Sikkerhedsanvisninger

















- Kontrollér, at netspændingen og netfrekvensen i strømnettet stemmer overens med oplysningerne på typeskiltet.
- Apparatet må ikke opstilles i nærheden af en varmekilde!
- Apparatet må kun opbevares, transporteres og anvendes opretstående!
- Brug kun væsker og gasser ved apparatet som opfylder retningslinjerne fra DAHLE.
- Apparatet må ikke åbnes!
- Apparatet må kun benyttes i lukkede rum ved 10–25 °C (50–77 °F) og ved en ikke-kondenserende luftfugtighed på mellem 15 % og 94%!
- Tjek at strømforsyningen er sikret på bygningssiden: maks. 16 A (US maks. 20 A).
- Lad ikke apparatet køre i tomgang!
- Apparatet er ikke bestemt til brug af personer (herunder børn) med nedsatte fysiske evner, sansefunktioner eller mentale færdigheder eller manglende erfaring og viden, med mindre de arbejder under opsyn eller får udførlig vejledning i brugen af apparatet af en sikkerhedsansvarlig person.



Makulatorens skal bortskaffes på fagligt og miljømæssigt forsvarlig vis på en autoriseret genbrugsplads. Ingen del af makulatorens eller indpakningen må bortskaffes sammen med husholdningsaffald.

1.3 Forklaring af symboler

	Vigtige oplysninger		Makulatorens skal opstilles, så den står sikkert på gulvet, og i en afstand på 100 mm fra væggen, så varmen kan slippe væk. Aktiver fastgøringsbremserne (afhænger af typen)		Rør ikke ved papirtilførslen med hænderne.
	Læs brugeroplysninger/sikkerhedsanvisninger		Må ikke anvendes i nærheden af brandbare væsker og gasser.		Rør ikke ved papirtilførslen med beklædningsgenstande!
	GIV AGT!		Må ikke anvendes i nærheden af brandbare væsker og gasser.		Rør ikke ved papirtilførslen med håret!
	OPMÆRKSOMHED! Risiko for elektrisk stød.		Automatisk start		Hold spraydåser fjernt fra apparatet!
	GIV AGT, bevægelige dele		Må ikke udsættes for fugt.		Fjern klips og hæfteklammer før makulering!
	GIV AGT, skarpe kanter		Denne makulator er ikke beregnet til at blive brugt af børn (produktet er ikke legetøj).		Sæt ikke disketter i!
	Må ikke anvendes i nærheden af ætsende stoffer.				Før der foretages vedligeholdelse af makulatorens, skal der slukkes for strømtilførslen!

- | | | | | | |
|--|--|---|--|---|---|
|  | Tekniske data - Forbeholdt tekniske ændringer! |  | Stik tjener som skilleanordning i strømforsyningen. |  | Makulatoren slukker automatisk efter længere tids drift og/eller overbelastning for at køle af. |
|  | Lydniveau i tomgang |  | Stikdåsen til lysnettet skal altid være let tilgængelig! |  | Vedligeholdelsesanvisninger/afhjælpning af fejl |
|  | Indtrækshastighed |  | Betjening |  | Opsamlingsbeholderen er fuld |
|  | Papir-partikelsnit |  | Makulator i stand-by |  | Mulige fejl |
|  | Kort-partikelsnit |  | Makulator i drift |  | Automatisk slukning ved åbent kabinet |
|  | Vægt |  | Automatisk slukning! | | |

HUOMIO!

Lue käyttö- ja turvallisuusohjeet huolellisesti ENNEN asiakirjasilppurin käyttöönottoa! Ohjeita on noudatettava!



Säilytä käyttöohje myöhempää käyttöä varten.

Sisällys

1	Tärkeitä tietoja	28
1.1	Tarkoituksenmukainen käyttö, tuotevastuu	28
1.2	Turvallisuusohjeet	29
1.3	Merkkien selitykset	29
1.4	Toimitussisältö	88
1.5	Tekniset tiedot	88
2	Käyttö	89
2.2	Laitteen liittäminen verkkovirtaan	89
2.3	Laitteen kytkeminen päälle	89
2.4	Paperin silppuaminen	90
2.10	Korttien silppuaminen	92
3	Huolto/häiriönpoisto	93
3.1	Leikkuujätteen tyhjentäminen	93
3.3	Säiliö/kansi auki	93
3.4	Ylikuumeneminen	94
3.6	Paperitukoksen manuaalinen poistaminen	94
3.8	Paperitukoksen automaattinen poistaminen	95
3.15	Laitteen puhdistaminen	97

1.1 Tarkoituksenmukainen käyttö, tuotevastuu

Asiakirjasilppuri on tarkoitettu paperin silppuamiseen. Mallista riippuen voidaan myös tuhota pieniä määriä seuraavia materiaaleja:

- CD-/DVD-levyt ja maksukortit (katso ”Tekniset tiedot”).
- paperiasiakirjoissa, käytössä tavanomaisena määränä, olemassa olevat niitit ja paperiliittimet (poikkeus: turvallisuustasojen P6 ja P7 laitteet).

Kulutus, epäasianmukaisesta käytöstä johtuvat vauriot sekä ulkopuolisen suorittamat toimenpiteet eivät kuulu tuotevastuun eivätkä takuun piiriin

Asiakirjasilppuri on suunniteltu käytettäväksi yksityiskojeissa ja normaalissa toimistoympäristössä.

Teknisissä tiedoissa ilmoitetun suorituskyvyn saavuttaminen riippuu seuraavista seikoista:

Yksittäisten, silputtavien arkki- enimmäismäärä seuraavissa olosuhteissa: Uudet tai öljytyt leikkausterät, kylmä moottori, teholähde nimellisjännitteellä ja -taajuudella (230V/50Hz, 120V/60Hz).

Poikkeamat näistä voivat johtaa huonompaan suorituskykyyn ja melun lisääntymiseen. Arkkit syötetään keskitetysti ja pituussuunnassa, 90° kulmassa. Arkkien käsittelyteho voi myös vaihdella paperin ominaisuuksista ja syöttötavasta riippuen.

1.2 Turvallisuusohjeet

- Tarkista, että sähköverkkoosi jännite ja taajuus täsmäävät tyyppikyltin tietojen kanssa.
- Älä aseta laitetta lämmönlähteen lähelle!
- Säilytä, kuljeta ja käytä laitetta ainoastaan pystyasennossa!
- Käytä laitteessa vain nesteitä ja kaasuja, jotka täyttävät DAHLEN vaatimukset!
- Käytä laitetta ainoastaan suljetuissa tiloissa 10–25 °C:ssa (50–77 °F:ssa) ja tiivistymättömässä 15–94 %:n ilmankosteudessa!
- Laitetta ei saa avata!
- Rakennuksen asennusten oikosukku suojaus on taattava: maks. 16 A (US maks. 20 A).
- Älä käytä laitetta tyhjänä!
- Laitetta ei ole tarkoitettu sellaisten henkilöiden käytettäväksi (lapset mukaan luettuna), joiden fyysiset, aistilliset tai henkiset kyvyt ovat rajoitettuja tai joilta puuttuu kokemus ja tieto, elleivät he työskentele valvonnan alaisina tai saa perusteellista ohjetta laitteen käytöstä turvallisuudesta vastaavalta henkilöltä.



Hävitä asiakirjasilppuri ammattimaisesti ja ympäristöystävällisesti valtuutetussa keräyspisteessä. Asiakirjasilppurin osia tai pakkausta ei saa laittaa talousjätteen sekaan.

1.3 Merkkien selitykset

	Tärkeä tieto		Aseta laite tukevasti lattialle 100 mm:n etäisyydelle seinästä, vältä kuumentumista suman vuoksi, lukitse seisontajarrut (mallista riippuvainen)		Paperinsyöttöön ei saa laittaa vaatekappaleita!
	Tietoa käyttäjälle/lue turvallisuusohjeet		Asiakirjasilppuria ei saa käyttää palavien nesteiden tai kaasujen läheisyydessä.		Paperinsyöttöön ei saa laittaa hiuksia!
	HUOMIO		Asiakirjasilppuria ei saa käyttää palavien nesteiden tai kaasujen läheisyydessä.		Pidä spraypullot kaukana!
	HUOMIO! Sähköiskun vaara.		Automaattinen käynnistys		Paperiliittimet ja niitit on poistettava ennen silppuamista!
	HUOMIO, liikkuvat osat		Ei saa altistua kosteudelle		Älä syöä diskettejä!
	HUOMIO, terävät reunat		Tämä asiakirjasilppuri ei sovellu lasten käyttöön (laite ei ole leikkikalu).		Irrota asiakirjasilppuri virtalähteestä ennen huoltotöitä!
	Asiakirjasilppuria ei saa käyttää syövyttävien aineiden läheisyydessä.		Paperinsyöttöön ei saa koskea käsin.		Tekniset tiedot – Oikeudet tekniisiin muutoksiin pidätetään!



Äänenvoimakkuus tyhjäkäynnissä



Sisäänvetonopeus



Paperin silppuleikkaus



Korttien silppuleikkaus



Paino



Verkkopistoke toimii virtalähteen katkaisijana.



Verkkopistorasia on oltava aina helposti tavoitettavissa!



Käyttö



Asiakirjasilppuri valmiustilassa



Asiakirjasilppuri toiminnassa



Automaattinen sammutus!



Pidempiaikaisessa käytössä ja/tai ylikuormituksen vuoksi asiakirjasilppuri kytkeytyy automaattisesti pois päältä jäähtymään.



Huolto-ohjeet/häiriöiden korjaus



Silppusäiliö täynnä



Mahdolliset häiriöt



Automaattinen sammutus avatulla kotelolla

no Bruksanvisning



OBS!

FØR du tar i bruk makuleringsmaskinen må du lese nøye gjennom bruksanvisningen og sikkerhetsinstruksene.



Anvisningene må anvendes!

Oppbevar bruksanvisningen for senere bruk.

Innholdsfortegnelse

1	Viktig informasjon.....	31
1.1	Forskriftsmessig bruk, garanti	31
1.2	Sikkerhetsinstruksjer.....	32
1.3	Piktogramforklaring.....	32
1.4	Leveringsomfang.....	88
1.5	Tekniske data	88
2	Betjening.....	89
2.2	Koble apparatet til strømmettet.....	89
2.3	Slå på apparatet.....	89
2.4	Papirmakulering	90
2.10	Kortmakulering	92
3	Vedlikehold/feilretting	93
3.1	Tøm skjæregods.....	93
3.3	Beholder/deksel er åpen(t).....	93
3.4	Overopphetet	94
3.6	Papirfeil, manuell inntrekking	94
3.8	Papirfeil, automatisk inntrekking	95
3.15	Rengjør apparatet.....	97

1.1 Forskriftsmessig bruk, garanti

Makuleringsmaskinen er konstruert for å makulere papir.

Avhengig av hvilken modell det dreier seg om, kan dessuten en liten mengde av de følgende materialene makuleres:

- CD-er/DVD-er, sjekk- og kredittkort (se Tekniske data).
- Binders og stifter som finnes i papirdokumenter i vanlig omfang (unntak: enheter i sikkerhetstrinn P6 og P7).

Slitasje, skader gjennom ufagmessig bruk samt inngrep fra tredje parter faller verken inn under forhandlergaranti eller produsentgaranti

Makuleringsmaskinen er konstruert til privat drift samt drift i normale kontoromgivelser.

Med hensyn til arkkapasiteten angitt under tekniske data gjelder følgende rammebetingelser:

Maksimalt antall ark som kan kuttes i en gjennomgang under følgende betingelser: Nye eller smurte kuttevalser, kald motor, strømforsyning med nominell spenning og frekvens (230V/50Hz; 120V / 60Hz).

Avvik kan føre til en lavere arkkapasitet og høyere driftsstøy. Arkene mates inn midtstilt og i lengderetningen ved 90°. Arkkapasiteten kan også variere alt etter papiregenskaper og tilførsel.

1.2 Sikkerhetsinstruksjer

















- Kontroller at spenningen og nettfrekvensen i strømnettet ditt stemmer overens med informasjonen på typeskiltet.
- Apparatet må ikke plasseres i nærheten av en varmekilde!
- Apparatet må kun lagres, transporteres og brukes stående!
- Man må kun benytte væsker og gass som tilsvarer DAHLE-direktivene på apparatet!
- Apparatet skal ikke åpnes!
- Ikke la apparatet gå på tomgang!
- Apparatet skal kun brukes i lukkede rom ved temperaturer fra 10 °C til 25 °C (50 °F bis 77 °F) og en ikke-kondenserende luftfuktighet fra 15 % til 94 %!
- Det må sørges for sikkerhet mot kortslutning av bygningstallasjonen: maks. 16 A (US maks. 20 A).
- Matekanaler må kun brukes enkeltvis!
- Apparatet er ikke bestemt til bruk av personer (gjelder også barn) med innskrenkede fysiske, sensoriske eller åndelige evner eller manglende erfaring og kunnskaper, med mindre de arbeider under tilsyn eller får en utførlig veiledning til bruken av apparatet av en person som er ansvarlig for sikkerheten.



Makuleringsmaskinen må kastes faglig korrekt og miljøvennlig ved et autorisert samlested for avfall. Ingen deler av makuleringsmaskinen eller emballasjen får kastes i husholdningsavfallet.

1.3 Piktogramlegende

	Viktig informasjon		Apparatet må plasseres stabilt på gulvet med en avstand på 100 mm til veggen, unngå oppvarming på grunn av kø/blokkering, Betjen parkeringsbremsen (typeavhengig)		Ikke berør papirinntaket med hendene.
	Les brukerinformatjonen/sikkerhetsinstruksene		Må ikke benyttes i nærheten av brennbare væsker eller gass.		Ikke berør papirinntaket med klesplagg!
	OBS		Må ikke benyttes i nærheten av brennbare væsker eller gass.		Ikke berør papirinntaket med hårene!
	MERK FØLGENDE! Fare for elektrisk støt.		Automatisk start		Spraybokser må holdes unna!
	OBS, bevegelige deler		Må ikke utsettes for fuktighet		Fjern binders og heftestifter før makulering!
	OBS, skarpe kanter		Denne makuleringsmaskinen er ikke ment til bruk av barn (produktet er ikke et leketøy).		Ikke før inn disketter!
	Må ikke benyttes i nærheten av etsende stoffer.		Denne makuleringsmaskinen er ikke ment til bruk av barn (produktet er ikke et leketøy).		Før vedlikeholdsarbeid må makuleringsmaskinen kobles fra strømnettet!

- | | | | | | |
|--|--|---|---|---|--|
|  | Tekniske data - Forbehold om tekniske endringer! |  | Strømkontakten brukes som skilleanordning for strømforsyningen. |  | Ved lengre drift og/eller overbelastning slås makuleringsmaskinen automatisk av for avkjøling. |
|  | Driftslydstyrke på tomgang |  | Stikkontakten må til enhver tid være lett tilgjengelig! |  | Vedlikeholdsinstrukser/ feilretting |
|  | Inntrekkshastighet |  | Betjening |  | Beholder full |
|  | Papir-partikkelsnitt |  | Makuleringsmaskin i beredskap |  | Mulige feil |
|  | Kort-partikkelsnitt |  | Makuleringsmaskin i drift |  | automatisk utkobling ved åpent hus |
|  | Vekt |  | Automatisk utkobling! | | |



sv Bruksanvisning



OBS!

Läs uppmärksamt igenom bruksanvisningen och säkerhetsanvisningarna INNAN dokumentförstöraren tas i drift.

Anvisningarna måste tillämpas!

Förvara bruksanvisningen för senare användning.



Innehållsförteckning

1	Viktig information.....	34
1.1	Ändamålsenlig användning, garanti.....	34
1.2	Säkerhetsanvisningar.....	35
1.3	Piktogramförklaring.....	35
1.4	Leveransens omfattning.....	88
1.5	Tekniska data.....	88
2	Manövrering.....	89
2.2	Ansluta apparaten till elnätet.....	89
2.3	Slå på apparaten.....	89
2.4	Förstöra dokument.....	90
2.10	Förstöra kort.....	92
3	Underhåll/felavhjälpning.....	93
3.1	Tömning av skuret material.....	93
3.3	Behållare/lock öppet.....	93
3.4	Överhettning.....	94
3.6	Pappersblockering manuell inmatning.....	94
3.8	Pappersblockering automatisk inmatning.....	95
3.15	Rengöring av apparaten.....	97

1.1 Ändamålsenlig användning, garanti

Dokumentförstöraren är avsedd för förstörelse av papper.

Allt efter modellvariant kan dessutom smärre mängder av följande material förstöras:

- cd-/dvd-skivor, bank- och kreditkort (se Tekniska data).
- vanliga häftklamrar och gem som används i pappersdokument (undantag: apparater med säkerhetsnivå P6 och P7).

Slitage, skador pga. felaktig användning samt ingrepp genom tredje part faller varken under den lagstadgade garantin eller tillverkarens garanti.

Dokumentförstöraren är utformad för att användas privat och i vanlig kontorsmiljö.

För bladeffekten som anges under tekniska data gäller följande förutsättningar:

Maximalt antal blad som får skäras i en genomgång under följande förutsättningar: Nya eller oljade skärvalsar, kall motor, strömförsörjning med märkspänning och märkfrekvens (230V/50 Hz; 120V/60 Hz).

Avvikelser kan leda till lägre bladeffekt och ökat driftsljud. Bladen matas in centrerat och på längden under 90°. Bladeffekten kan också variera beroende på pappersegenskaper och inmatning.

1.2 Säkerhetsanvisningar

- Kontrollera att elnätets spänning och nätfrekvens överensstämmer med uppgifterna på typskylten.
- Ställ inte upp apparaten i närheten av en värmekälla!
- Förvara, transportera och använd apparaten endast stående!
- Använd endast vätskor och gaser på apparaten som motsvarar DAHLE-riktlinjerna!
- Apparaten får inte öppnas!
- Använd endast apparaten inomhus, vid 10 °C till 25 °C (50 °F till 77 °F) och en ej kondenserande luftfuktighet på 15 % till 94 %!
- Se till att fastighetens installation är kortslutningssäker: max. 16 A (USA max. 20 A).
- Använd inte apparaten på tomgång!
- Apparaten är inte avsedd att användas av personer (inklusive barn) med nedsatt fysisk, sensorisk eller mental kapacitet eller bristande erfarenhet och kunskap, såvida de inte arbetar under uppsikt eller erhåller en utförlig anvisning om hur apparaten används av en person som ansvarar för säkerheten.



Avfallshandla dokumentförstöraren korrekt och miljörätt hos ett auktoriserat uppsamlingsställe. Kasta in några delar av dokumentförstöraren eller förpackningen i hushållssoporna.

1.3 Piktogramförklaring



Viktig information



Läs användarinstruktionen/säkerhetsanvisningarna



OBS!



UPPMÄRKSAMHET! Risk för elektrisk stöt.



OBS, rörliga delar



OBS, skarpa kanter



Använd inte apparaten i närheten av frätande ämnen.



Placera apparaten stabilt på golvet och med 100 mm avstånd till väggen, undvik värmeackumulering, använd parkeringsbromsen (typberoende)



Använd inte apparaten i närheten av brännbara vätskor eller gaser.



Automatisk start



Utsätt inte apparaten för väta.



Denna dokumentförstörare får inte användas av barn (produkten är ingen leksak)!



Vidrör inte pappersinmatningen med händerna.



Vidrör inte pappersinmatningen med klädesplagg!



Vidrör inte pappersinmatningen med håret!



Håll sprayburkar på avstånd!



Ta bort gem och häftklammer före förstörelseprocessen!



Lägg inte in några disketter!



Koppla bort dokumentförstöraren från elnätet innan underhållsarbeten påbörjas!



Tekniska data - Med reservation för tekniska ändringar!



Driftsljudnivå på tomgång



Inmatningshastighet



Papper partikelsnitt



Kort partikelsnitt

- | | | | | | |
|--|---|--|---|--|--|
| | Vikt | | Dokumentförstöraren i beredskap | | Underhållsanvisningar/ åtgärder vid störningar |
| | Stickkontakten fungerar som fränskiljningsanordning för strömförsörjningen. | | Dokumentförstöraren i drift | | Behållaren full |
| | Nätuttaget måste alltid vara lättåtkomligt! | | Automatisk avstängning! | | Möjliga störningar |
| | Manövrering | | Vid längre drift och/eller överbelastning stängs dokumentförstöraren automatiskt av för att svalna. | | automatisk fränkoppling vid öppet hölje |

sl Navodilo za uporabo



POZOR!

PRED začetkom uporabe uničevalnika dokumentov pozorno preberite navodilo za uporabo in varnostne napotke.

Napotke morate upoštevati!

Navodilo za uporabo shranite za poznejšo uporabo.



Kazalo vsebine

1	Pomembne informacije	37
1.1	Namenska uporaba, jamstvo	37
1.2	Varnostna navodila	38
1.3	Legenda piktogramov	38
1.4	Obseg dobave	88
1.5	Tehnični podatki	88
2	Upravljanje	89
2.2	Priključitev naprave na električno omrežje	89
2.3	Vklop naprave	89
2.4	Uničevanje papirja	90
2.10	Uničevanje kartic	92
3	Vzdrževanje/odpravljanje napak	93
3.1	Praznjenje razrezanega materiala	93
3.3	Odprta posoda/pokrov	93
3.4	Pregrevanje	94
3.6	Zastoj papirja pri ročnem podajanju	94
3.8	Zastoj papirja pri samodejnem podajanju	95
3.15	Čiščenje naprave	97

1.1 Namenska uporaba, jamstvo

Uničevalnik dokumentov je namenjen uničevanju papirja.

V odvisnosti od modela se lahko poleg papirja uničijo tudi majhne količine naslednjih materialov:

- CD/DVD, čekovne in kreditne kartice (glejte tehnične podatke).
- sponke za spenjanje in pisarniške sponke, ki so v običajnem obsegu vsebovane v papirni dokumentaciji (izjema: priprave varnostne stopnje P6 in P7).

Obraba, škoda zaradi nepravilne uporabe ter posegi tretjih oseb ne podlegajo ne jamstvu ne garanciji

Uničevalnik dokumentov je zasnovan za uporabo v zasebne namene in v običajnem pisarniškem okolju.

Glede na spodnje tehnične podatke o zmogljivosti obdelanih listov veljajo naslednji okvirni pogoji:

Največje število listov, ki bodo pod naslednjimi pogoji razrezani v enem postopku: Novi, morda naoljeni rezalni valji, hladni motor, napajanje s tokom z nazivno napetostjo in nazivno frekvenco (230V/50 Hz; 120V/60 Hz).

Odstopanja lahko povzročijo manjšo zmogljivost obdelanih listov in glasnejši hrup delovanja. Liste je treba dovajati po sredini in pod kotom 90°. Odvisno od lastnosti papirja in dovajanja lahko prav tako odstopa zmogljivost obdelave listov.

1.2 SVarnostni napotki



- Preverite, ali se napetost in frekvenca električnega omrežja ujemata s podatki na tipski tablici.
- Naprave ne postavljajte v bližino virov toplote.
- Napravo skladiščite, transportirajte in uporabljajte izključno v pokončnem položaju!
- Na napravi uporabljajte samo tekočine in pline, ki ustrezajo smernicam podjetja DAHLE!
- Naprave ne smete odpirati!
- Zagotovite, da je napeljava v zgradbi zaščiten pred kratkim stikom: maks. 16A (ZDA maks. 20A).
- Aparat uporabljajte samo v zaprtih prostorih pri temperaturi 10°C do 25°C (50°F do 77°F) in pri zračni vlažnosti brez nevarnosti kondenziranja od 15% do 94%!















- Naprava ne sme obratovati v prostem teku!
- Aparat ni namenjen uporabi s strani oseb (vključno z otroki) z omejenimi fizičnimi, senzornimi ali duševnimi sposobnostmi ali s pomanjkljivimi izkušnjami in znanjem, razen, če delajo pod nadzorom ali pa jih oseba, odgovorna za varnost, temeljito pouči o uporabi naprave.



Uničevalnik dokumentov strokovno in okolju prijazno odvrzite med odpadke na pooblaščenem zbirnem mestu. Delov uničevalnika dokumentov ali embalaže ne čečite med hišne odpadke.

1.3 Legenda piktogramov

	Pomembne informacije		Napravo postavite na tla v stabilen položaj 100 mm od stene, preprečite zadrževanje toplote, pritegnite fiksirne zavore (odvisno od tipa)		Dovoda papirja se ne dotikajte z lasmi!
	Preberite uporabniške informacije/varnostne napotke		Ne uporabljajte v bližini gorljivih tekočin ali plinov.		Razpršilnike držite proč od naprave!
	POZOR		POZOR! Nevarnost električnega udara.		Pred uničevanjem dokumentov z njih odstranite vse sponke!
	POZOR, gibljivi deli		Avtomatski zagon		Ne vstavljajte diskete!
	POZOR, ostri robovi		Ne izpostavljajte vlagi.		Pred vzdrževalnimi deli uničevalnik dokumentov odklopite od električnega napajanja!
	Ne uporabljajte v bližini jedkih snovi.		Tega uničevalnika dokumentov ne smejo uporabljati otroci (izdelek ni igrača).		Tehnični podatki - pridržujemo si pravico do tehničnih sprememb!
	Ne uporabljajte v bližini otrok.		Dovoda papirja se ne dotikajte z rokami.		Obratovalna glasnost v prostem teku
			Dovoda papirja se ne dotikajte z oblačili!		

- | | | |
|---|---|---|
|  <p>Hitrost uvleka</p> |  <p>Upravljanje</p> |  <p>Navodila za vzdrževanje / odpravljanje napak</p> |
|  <p>Rezanje papirja na delce</p> |  <p>Uničevalnik dokumentov v pripravljenosti</p> |  <p>Posoda je polna</p> |
|  <p>Rezanje kartic na delce</p> |  <p>Uničevalnik dokumentov v obratovanju</p> |  <p>Možne motnje</p> |
|  <p>Teža</p> |  <p>Avtomatski izklop!</p> |  <p>avtomatski izklop pri odprtem ohišju</p> |
|  <p>Omrežni vtič služi kot ločilna priprava električnega napajanja.</p> |  <p>Pri dolgotrajnem obratovanju in/ali preobremenitvi se uničevalnik dokumentov avtomatsko izklopi, da se ohladi.</p> | |
|  <p>Omrežna vtičnica mora biti vedno lahko dostopna!</p> | | |



hr Upute za uporabu



PAŽNJA!

PRIJE prve uporabe uništavača dokumenata pažljivo pročitajte Upute za uporabu i sigurnosne napomene i pridržavajte ih se!

Obavezno poštujujte sve napomene!
Sačuvajte ove upute za kasniju uporabu.



Sadržaj

1	Važne informacije	40
1.1	Namjenska uporaba, jamstvo	40
1.2	Sigurnosne upute	41
1.3	Legenda piktoograma	41
1.4	Opseg isporuke	88
1.5	Tehnički podaci	88
2	Uporaba	89
2.2	Priključivanje uređaja na električnu mrežu	89
2.3	Uključivanje uređaja	89
2.4	Uništavanje dokumenata	90
2.10	Uništavanje kartica	92
3	Održavanje/otklanjanje smetnji	93
3.1	Pražnjenje odrezaka	93
3.3	Otvoren spremnik/poklopac	93
3.4	Pregrijavanje	94
3.6	Zastoj papira ručnog uvlačenja	94
3.8	Zastoj papira automatskog uvlačenja	95
3.15	Čišćenje uređaja	97

1.1 Namjenska uporaba, jamstvo

Uništavač dokumenata namijenjen je uništavanju papira.

Ovisno o vrsti modela, moguće je uništavanje manje količine sljedećih materijala:

- CD-i, DVD-i, čekovne i kreditne kartice (vidi Tehničke podatke).
- spajalice i klamerice koje se nalaze u papirnatost dokumentaciji u uobičajenoj količini (iznimka: uređaji sa stupnjem sigurnosti P6 i P7).

Trošenje, oštećenja zbog neprikladne uporabe i zahvati trećih strana nisu obuhvaćeni jamstvom ni garancijom.

Uništavač dokumenata namijenjen je za privatnu uporabu i uobičajeno uredsko poslovanje.

U vezi s količinom listova koja je navedena u tehničkim podacima, vrijede sljedeći okvirni uvjeti:

Maksimalni broj listova koji se mogu izrezati u jednom prolazu pri sljedećim uvjetima: Novi i prema potrebi podmazani valjci za rezanje, hladan motor, napajanje strujom s nazivnim naponom i nazivnom frekvencijom (230V/50Hz; 120V/60Hz).

Odstupanja mogu dovesti do smanjene količine listova i povećane buke pri okretanju. Listove treba umetati po sredini i uzdužno pod kutom od 90°. Ovisno o svojstvima papira i načinu umetanja, također može varirati i količina listova.

1.2 Sigurnosne upute















- Provjerite odgovaraju li napon i frekvencija mreže vašer električne mreže podacima na natpisnoj pločici.
- Nemojte uređaj postaviti u blizini izvora topline!
- Ovaj stroj skladištite, prevozite i koristite isključivo u uspravnom položaju!
- Prilikom rada stroja koristite samo tekućine i plinove koji ispunjavaju zahtjeve iz smjernica tvrtke DAHLE!
- Uređaj se ne smije otvarati!
- Stroj ne smije raditi u praznom hodu!
- Uređaj upotrebljavajte isključivo u zatvorenim prostorima na temperaturi od 10 °C do 25 °C (50 °F do 77 °F) i na vlažnosti zraka bez kondenzacije od 15 % do 94 %!
- Instalacije zgrade treba osigurati od kratkog spoja: maks. 16 A(SAD maks. 20 A).
- Otvore za uvlačenje koristiti samo pojedinačno!
- Uređajem ne smiju rukovati osobe (uključujući djecu) s ograničenim fizičkim, osjetilnim ili intelektualnim sposobnostima ili s nedostatkom iskustva i znanja, osim ako rade pod nadzorom ili ih je osoba odgovorna za sigurnost iscrpno upoznala s rukovanjem uređajem.



Uništavač dokumenata zbrinite stručno i u skladu s propisima o zaštiti okoliša na ovlaštenom deponiju. Dijelove uništavača dokumenata ili ambalaže ne odlažite u kućanski otpad.

1.3 Legenda pitkograma

- | | | | | | |
|--|---|---|--|---|---|
|  | Važne informacije |  | Stroj postavite na čvrsto tlo na udaljenosti 100 mm od zida i izbjegavajte gomilanje topline! Aktivirajte kočnice za zaustavljanje (ovisno o tipu) |  | Otvor za ulaganje papira ne dodirujte kosom! |
|  | Pročitajte korisničke informacije/sigurnosne napomene |  | Uređaj nemojte koristiti u blizini zapaljivih tekućina ili plinova. |  | Držite podalje od sprejeva! |
|  | PAŽNJA |  | PAŽNJA! Opasnost od strujnog udara. |  | Prije uništavanja dokumenata ukloniti spajalice i klamerice! |
|  | PAŽNJA! Opasnost od strujnog udara. |  | Automatsko pokretanje uređaja |  | Nemojte uvoditi diskete! |
|  | PAŽNJA pokretni dijelovi |  | Uređaj nemojte izlagati vlazi |  | Prije radova održavanja isključite uništavač dokumenata iz napajanja strujom! |
|  | PAŽNJA, oštri rubovi |  | Ovim uništavačem dokumenata ne smiju rukovati djeca (proizvod nije igračka). |  | Tehnički podaci - Pridržano pravo tehničkih izmjena! |
|  | Uređaj nemojte koristiti u blizini korozivnih tvari. |  | Otvor za ulaganje papira nemojte dodirivati rukama. |  | Razina buke pri radu u praznom hodu |
| | |  | Otvor za ulaganje papira ne dodirujte komadima odjeće! |  | Brzina uvlačenja |

- | | | | | | |
|--|--|---|--|---|---|
|  | Rezanje papira u sitne dijelove |  | Uporaba |  | Napomene o održavanju/
otklanjanje smetnji |
|  | Rezanje kartica u sitne dijelove |  | Uništavač dokumenata u stanju pripravnosti |  | Spremnik pun |
|  | Masa |  | Uništavač dokumenata u radu |  | Moguće smetnje |
|  | Utikač služi za odvajanje električnog napajanja |  | Automatsko isključivanje! |  | automatsko gašenje kod otvorenog kućišta |
|  | Mrežna utičnica mora uvijek biti lako pristupačna! |  | Kod dužeg rada i/ili preopterećenja uništavač dokumenata se automatski gasi radi hlađenja. | | |

hu Használati utasítás



FIGYELEM!

Az iratmegsemmisítő üzembe helyezése **ELŐTT** figyelmesen olvassa el a kezelési és biztonsági utasításokat.



Az utasításokat alkalmazni kell. Őrizze meg a kezelési utasítást a későbbi használatához.

Tartalomjegyzék

1	Fontos információk	43
1.1	Rendeltetés szerinti használat, garancia	43
1.2	Biztonsági előírások	44
1.3	A piktogramok jelmagyarázata	44
1.4	A szállítmány tartalma	88
1.5	Műszaki adatok	88
2	Kezelés	89
2.2	A készülék hálózatra kapcsolása	89
2.3	A készülék bekapcsolása	89
2.4	Papír megsemmisítés	90
2.10	Kártyamegsemmisítés	92
3	Karbantartás/hibaelhárítás	93
3.1	A vágott anyag ürítése	93
3.3	Tároló/fedél nyitva	93
3.4	Túlmelegedés	94
3.6	Papír elakadás, kézi behúzás	94
3.8	Papír elakadás, automatikus behúzás	95
3.15	A készülék tisztítása	97

1.1 Rendeltetés szerinti használat, garancia

Az iratmegsemmisítő papírok megsemmisítésére készült. Egyes modellek kis mennyiségben alkalmasak a következő anyagok megsemmisítésére is:

- CD-k/DVD-k, csekk- és hitelkártyák (lásd a műszaki adatokat).
- a papírdokumentumokban a szokásos felhasználói terjedelemben előforduló tűző- és irodai kapcsok (kivételek: P6 és P7 biztonsági fokozatú készülékek).

A kópásból, nem rendeltetészerű használatból és külső beavatkozásokból származó károokra a garancia nem érvényesíthető

Az iratmegsemmisítő magáncélú és normál irodai környezetben történő használatra készült.

Az alábbi műszaki adatokban megadott lapszámra vonatkozóan az alábbi keretfeltételek vonatkoznak:

Az egy ciklusban, az alábbi feltételek mellett vágható lapok maximális darabszáma: Új, szükség esetén beolajozott aprítóhengerek, hideg motor, áramellátás névleges feszültséggel és névleges frekvencia (230V/50Hz; 120V/60Hz).

Az adatoktól eltérés kisebb lapszámhoz vezethet és a készülék működése nagyobb zajjal járhat. A lapok adagolása közepén és hosszában 90°-nál kisebb szögben történik. A papír tulajdonságaitól és az adagolástól függően a darabszám változhat.

1.2 Biztonsági utasítások

















- Ellenőrizze, hogy az elektromos hálózat feszültsége és frekvenciája megfelel-e az adattáblán szereplő értékeknek.
- Biztonsági utasítások
- A készüléket nem szabad hőforrások közelében elhelyezni.
- A készülék kizárólag álló helyzetben tárolható, szállítható és üzemeltethető.
- A készülékhez csak olyan folyadékokat és gázokat használjon, amelyek megfelelnek a DAHLE előírásainak.
- A készüléket tilos felnyitni.
- A készüléket kizárólag zárt helyiségekben, 10 és 25 °C közötti hőmérsékleten, kondenzációmentes, 15 és 94% közötti páratartalom mellett üzemeltesse.
- Az épület elektromos hálózatában biztonsági rövidzárlat-védelmet kell felszerelni: max. 16 A (US max. 20 A).
- Ne működtesse üresen a készüléket.
- A készülék nem csökkent fizikai, érzékszervi vagy szellemi képességű, vagy tapasztalat és ismeretek nélküli személyek (ideértve a gyerekeket is) által történő használatra készült, kivéve, ha felügyelet mellett használják a készüléket vagy a készülék használatához részletes utasítást kapnak egy olyan személytől, aki a biztonságért felelős.



Az iratmegsemmisítő szakszerű, környezetbarát módon selejtezze le és adja le egy átvételre jogosult gyűjtőhelyen. Az iratmegsemmisítő vagy a csomagolás semmilyen részét ne helyezze a háztartási hulladék közé.

1.3 Piktogramok magyarázata

- | | | | | | |
|--|---|--|--|--|--|
| | Fontos információ | | A készüléket biztonságosan állítsa a talajra a faltól 100 mm távolságra és ne hagyja, hogy a hó felhalmozódjon benne. Nyomja le a rögzítőféket (típusfüggő). | | Ne érjen hozzá a ruhájával a papíradagolóhoz. |
| | Olvassa el a kezelési/biztonsági utasításokat | | Ne használja gyúlékony folyadékok vagy gázok környezetében. | | Ne érintse haját a papíradagolóhoz. |
| | FIGYELEM | | Automatikus indítás | | Tartsa távol a szóróflakonokat. |
| | FIGYELEM! Áramütés veszélye. | | Ne használja nedves környezetben. | | Az iratok megsemmisítése előtt távolítsa el belőlük a tűzőkapcsokat és gemkapcsokat. |
| | FIGYELEM, mozgó alkatrészek | | A készüléket nem gyermekek általi használatra tervezték (a termék nem játék). | | Ne helyezzen be lemezeket. |
| | FIGYELEM, éles szélek | | Ne érjen hozzá kézzel a papíradagolóhoz. | | A karbantartás előtt válassza le az iratmegsemmisítőt az elektromos hálózatról. |
| | Ne használja maró anyagok környezetében. | | | | Műszaki adatok – A műszaki változtatások jogát fenntartjuk. |

- | | | |
|--|---|--|
|  <p>Zajszint üresjáratban</p> |  <p>A hálózati csatlakozónak mindig könnyen hozzáférhetőnek kell lennie.</p> |  <p>Az iratmegsemmisítő hosszú használat és/vagy túlterhelés miatt automatikusan leáll, hogy lehűlhessen.</p> |
|  <p>Behúzási sebesség</p> |  <p>Kezelés</p> |  <p>Karbantartási utasítások/hibaelhárítás</p> |
|  <p>Papír – keresztvágás</p> |  <p>Az iratmegsemmisítő használatra kész</p> |  <p>Megtelt a tartály</p> |
|  <p>Kártyák – keresztvágás</p> |  <p>Az iratmegsemmisítő működik</p> |  <p>Lehetséges problémák</p> |
|  <p>Tömeg</p> |  <p>Automatikus kikapcsolás!</p> |  <p>Automatikus kikapcsolás nyitott fedélnél</p> |
|  <p>A hálózati dugó az áramellátás leválasztására szolgál.</p> | | |



ru Инструкция по применению



ВНИМАНИЕ!

ПЕРЕД вводом в эксплуатацию машины для уничтожения деловых бумаг **внимательно прочитайте руководство по эксплуатации и указания по технике безопасности.**

Строго придерживайтесь указаний!

Сохраните руководство по эксплуатации для использования в будущем.



Оглавление

1	Важная информация.....	46
1.1	Применение по назначению, гарантийные обязательства	46
1.2	Указания по технике безопасности.....	47
1.3	Объяснение пиктограмм	47
1.4	Комплект поставки	88
1.5	Технические характеристики	88
2	Работа с устройством.....	89
2.2	Подключение устройства к электросети	89
2.3	Включение устройства	89
2.4	Уничтожение бумаг	90
2.10	Уничтожение пластиковых карт	92
3	Техническое обслуживание и устранение неисправностей	93
3.1	Удаление разрезанного материала.....	93
3.3	Емкость/крышка открыта.....	93
3.4	Перегрев.....	94
3.6	Ручная подача при образовании затора	94
3.8	Автоматическая подача при образовании затора	95
3.15	Очистка устройства.....	97

1.1 Применение по назначению, гарантийные обязательства

Этот аппарат предназначен для уничтожения деловых бумаг.

В зависимости от модели аппарат может также уничтожать небольшое количество следующих материалов:

- CD-/DVD-диски, чековые и кредитные карточки (см. раздел «Технические характеристики»);
- скобы и скрепки, используемые для скрепления обычной документации (исключение: оборудование с уровнем секретности P6 и P7).

Гарантийные обязательства не распространяются на износ и повреждения, вызванные ненадлежащим использованием аппарата или вмешательством третьих лиц

Аппарат предназначен для домашнего пользования и для офисов с небольшим документооборотом.

Для указанной в технических характеристиках производительности (в листах бумаги) действуют следующие общие условия:

Максимальное количество листов, которое можно разрезать за один цикл при следующих условиях: новые или смазанные маслом режущие валы, холодный мотор, питание от сети с номинальными напряжением и частотой (230 В/50 Гц; 120 В/60 Гц).

Отклонения могут привести к снижению производительности (в листах бумаги) и повышению шума во время работы. Листы подаются по центру в продольном направлении под углом 90°. Производительность зависит от свойств бумаги и способа подачи.

1.2 Указания по технике безопасности











- Убедитесь, что напряжение и частота используемой электросети соответствуют данным, приведенным на информационной табличке.
- Указания по технике безопасности
- Не устанавливайте машину вблизи источников тепла!
- Машину следует хранить, транспортировать и использовать только в вертикальном положении!
- Возле машины использовать только жидкости и газы, соответствующие директивам компании DAHLE!
- Открывать машину запрещено!
- Использовать аппарат только в закрытых помещениях при температуре от 10 до 25°C (от 50 до 77°F) и влажности воздуха, не способствующей образованию конденсата (от 15 до 94%)!
- Обеспечить защиту проводки здания от коротких замыканий: макс. 16 А (в США — макс. 20 А).
- Не допускать работы машины на холостом ходу!
- Аппарат не предназначен для использования лицами (включая детей) с ограниченными физическими, сенсорными или умственными способностями, а также лицами, не обладающими надлежащим опытом и знаниями, за исключением случаев, когда они работают под присмотром или получили инструкции по эксплуатации аппарата от лица, ответственного за безопасность.



Утилизировать машину для уничтожения бумаг с учетом требований по охране окружающей среды, сдав ее в специализированный пункт сбора отходов. Не выбрасывать детали машины для уничтожения бумаг или компоненты упаковки вместе с бытовыми отходами.

1.3 Объяснение пиктограмм

	Важная информация		Установить машину устойчиво на полу на расстоянии 100 мм от стены, не допускать образования теплового застоя, активировать стопор (в зависимости от типа)		Не допускать контакта одежды с механизмом подачи бумаги!
	Прочитать информацию для пользователя/указания по технике безопасности		Не использовать рядом с воспламеняющимися жидкостями или газами.		Не допускать контакта волос с механизмом подачи бумаги!
	ВНИМАНИЕ		Автоматический запуск		Не хранить вблизи машины аэрозольные баллончики!
	ВНИМАНИЕ! Опасность поражения электрическим током.		Не подвергать воздействию влаги		Перед процессом уничтожения снять с бумаги все скрепки и скобы!
	ВНИМАНИЕ, движущиеся части		Данная машина для уничтожения бумаг не предназначена для использования детьми (изделие не является игрушкой).		Не использовать для уничтожения дискет!
	ВНИМАНИЕ, острые края		Не прикасаться руками к механизму подачи бумаги.		Перед проведением работ по техническому обслуживанию отключить машину от электропитания!
	Не использовать вблизи едких веществ.				Технические характеристики – Возможны технические изменения!

- | | | | | | |
|--|--|---|--|---|--|
|  | Уровень рабочего шума на холостом ходу |  | Работа с машиной |  | Емкость заполнена |
|  | Скорость подачи |  | Машина для уничтожения деловых бумаг в состоянии готовности |  | Возможные неисправности |
|  | Перекрестная резка бумаги |  | Машина для уничтожения деловых бумаг в рабочем состоянии |  | автоматическое отключение при открывании корпуса |
|  | Перекрестная резка пластиковых карт |  | Автоматическое выключение! | | |
|  | Масса |  | При длительной эксплуатации и/или перегрузке машина для уничтожения бумаг автоматически отключается для остывания. | | |
|  | Сетевой штекер используется для отсоединения от электросети. |  | Указания по техническому обслуживанию/устранение неисправностей | | |
|  | Обеспечить быстрый доступ к сетевой розетке! | | | | |

et Juhised



TÄHELEPANU!

Lugege kasutusjuhend ja ohutusjuhised tähelepanelikult ENNE paberipurustaja kasutamist läbi.



Juhistest tuleb kinni pidada!

Hoidke kasutusjuhend hilisemaks kasutamiseks alles.

Sisukord

1	Tähtis teave	49
1.1	Sihtotstarbeline kasutamine, garantii	49
1.2	Ohutusjuhised	50
1.3	Piktogrammide legend	50
1.4	Pakendi sisu	88
1.5	Tehnilised andmed	88
2	Käsitsemine	89
2.2	Seadme ühendamine vooluvõrku	89
2.3	Seadme sisselülitamine	89
2.4	Paberi purustamine	90
2.10	Kaartide purustamine	92
3	Hooldus/tõrgete kõrvaldamine	93
3.1	Purustatud materjali kõrvaldamine	93
3.3	Mahuti/kaas avatud	93
3.4	Ülekuumenemine	94
3.6	Manuaalse sissetõmbe paberiummistus	94
3.8	Automaatse sissetõmbe paberiummistus	95
3.15	Seadme puhastamine	97

1.1 Sihtotstarbeline kasutamine, garantii

Paberipurustaja on mõeldud paberi purustamiseks. Olenevalt mudelist võib väheses koguses purustada ka järgmisi materjale:

- CD-/DVD-plaadid, panga- ja krediitkaardid (vt Tehnilised andmed).
- paberdokumentides tavalisel kasutusmääral olevad klambrid ja kirjaklambrid (väljaarvatud P6 ja P7 ohustaseme seadmed).

Kulumisest, mittesihtotstarbelisest kasutamisest ja ka kolmandate isikute läbiviidud parandustöödest põhjustatud kahjud ei kuulu ei tagatise ega garantii alla.

Paberipurustaja on mõeldud kasutamiseks erasfääris ja tavapärasel bürookeskkonnas.

Tehnilistes andmetes esitatud lehe lõikamise võimsusele kehtivad alljärgnevad raamtingimused.

Maksimaalne arv lehti, mida ühe töökäiguga saab lõigata, kui tingimused on järgmised: uued, vajaduse korral õlitatud lõikerullikud, külm mootor, vooluvarustus nimipingega ja nimisagedusega (230V / 50Hz; 120V / 60Hz).

Kõrvalekallete tagajärjeks võib lehtede lõikamise võimsus olla madalam ja müratase suurem. Lehed tuleb sisestada keskelt ja pikuti 90° nurga all. Ka paberi omadused ja sisestamise viis mõjutavad lehe lõikamise võimsust.

1.2 Ohutusjuhised

















- Kontrollige, et teie vooluvõrgu pinge ja võrgusagedus vastavad tüübisildi andmetele.
- Seadet ei tohi paigutada soojusallika lähedusse!
- Seadet tohib ainult püstises asendis ladustada, transportida ja käitada!
- Kasutage seadmes ainult DAHLE nõuetele vastavaid vedelikke ja gaase!
- Seadet ei tohi avada!
- Seadet tohib kasutada vaid suletud ruumides, mille temperatuur jääb vahemikku 10°C kuni 25°C (50°F kuni 77°F) ja mittekondenseeruv õhuniiskus vahemikku 15% kuni 94%.
- Tagage hoone paigalduse lühisekindlus max 16A(US max 20A).
- Seadet ei tohi tühjalt käitada!
- Seade pole mõeldud kasutamiseks piiratud füüsiliste, sensorsete või vaimsete võimete ga isikute poolt (sh lapsed) või väheste kogemuste ja teadmistega, välja arvatud juhul, kui neid seadme kasutamisel juhendatakse või antakse üksikasjalikud juhised ohutuse eest vastutava isiku poolt.



Viige kõrvaldamisele kuuluv dokumendipurustaja ettenähtud korras ja keskkonnanahoidlikult heakskiidetud kogumiskohta. Ärge visake paberipurustaja osi ega pakendit tavalisse olmeprügisse.

1.3 Piktogrammide legend

	Oluline teave		Paigutage seade seinast 100 mm kaugusele põrandale seisma, tagage sooja õhu äravool. Rakendage seisupidurit (olenevalt mudelist)		Ärge puudutage paberi sisestusava riietega!
	Lugege kasutusteavet/ohutismärkusi		Ärge kasutage seadet põlemisohtrlike ainete või gaaside läheduses.		Ärge puudutage paberi sisestusava juustega!
	TÄHELEPANU		Ärge kasutage seadet põlemisohtrlike ainete või gaaside läheduses.		Hoidke aerosoolpurgid eemal!
	TÄHELEPANU! Elektrilöögi oht.		Automaatne käivitumine		Enne purustamist eemaldage kirja- ja vihikuklambri!
	TÄHELEPANU, liikuvad osad		Ärge jätke niiskesse keskkonda		Ärge sisestage seadmesse diskette!
	TÄHELEPANU, teravad servad		Dokumentipurustaja ei sobi lastele kasutamiseks (toode pole mänguasi).		Enne hooldustöid lahutage paberipurustaja vooluvõrgust!
	Ärge kasutage seadet happeliste ainete läheduses.		Ärge puudutage paberi sisestusava kätega!		Tehnilised andmed –tootjal on õigus teha tehnilisi muudatusi!

- | | | | | | |
|--|---|---|--|---|---|
|  | Müratase seadme tühkäigu puhul |  | Pistikupesale peab olema tagatud vaba juurdepääs! |  | Hooldusjuhised / tõrgete kõrvaldamine |
|  | Etteandekiirus |  | Käsitsemine |  | Mahuti on täis |
|  | Paberi peenestamine |  | Paberipurustaja on kasutusvalmis |  | Võimalikud tõrked |
|  | Kaartide peenestamine |  | Paberipurustaja töötab |  | automaatne väljalülitamine avatud korpuse puhul |
|  | Kaal |  | Automaatne väljalülitus! | | |
|  | Seadme saab vooluvõrgust eraldada pistiku abil. |  | Pikemaajalise kasutamise ja/või ülekoormuse puhul lülitub dokumendipurustaja jahtumiseks automaatselt välja. | | |

lt Naudojimo instrukcija



DĖMESIO!

Prieš pradėdami naudoti dokumentų smulkintuvą atidžiai perskaitykite naudojimo instrukciją ir saugos instrukcijas.

Būtina vadovautis instrukcijomis!

Saugokite instrukcijas, kad paskaitytumėte ir vėliau.



Turinys

1	Svarbi informacija	52
1.1	Naudojimas pagal paskirtį, garantija	52
1.2	Saugos nurodymai	53
1.3	Piktogramos legenda	53
1.4	Komplektacija	88
1.5	Techniniai duomenys	88
2	Valdymas	89
2.2	Prietaiso įjungimas į elektros tinklą	89
2.3	Prietaiso įjungimas	89
2.4	Popieriaus smulkinimas	90
2.10	Kortelių naikinimas	92
3	Techninė priežiūra / trikčių šalinimas	93
3.1	Nuokarpų pašalinimas	93
3.3	Atidaryta dėžė / dangtis	93
3.4	Perkaitimas	94
3.6	Susigrūdęs popierius tiekiant rankiniu būdu	94
3.8	Susigrūdęs popierius tiekiant automatinio būdu	95
3.15	Prietaiso valymas	97

1.1 Naudojimas pagal paskirtį ir garantija

Dokumentų naikiklis skirtas popieriui naikinti.

Be to, priklausomai nuo modelio varianto, galima naikinti nedidelius toliau nurodytų medžiagų kiekius:

- CD ir DVD diskus, debetines ir kreditines korteles (žiūrėkite skyrių „Techniniai duomenys“).
- popieriniuose dokumentuose esančias sąsagėles bei kanceliarines sąvaržėles, jei jų kiekis neviršija įprastai naudojamo (išimtis: P6 ir P7 saugumo klasių prietaisai).

Gedimams, atsiradusiems dėl susidėvėjimo, netinkamo naudojimo, o taip pat – dėl trečiųjų šalių atliktų intervencijų, netaikomi nei įstatymų numatyti garantiniai įsipareigojimai, nei gamintojo savanoriškai suteikiama garantija.

Dokumentų naikiklio konstrukcija yra pritaikyta naudoti buityje ir įprastinėje biuro aplinkoje.

Lapų apdorojimo našumui, nurodytam techniniuose duomenyje, galioja tokios pagrindinės sąlygos: Maksimalus lapų skaičius, kurie vienos eigos metu pjaustomi tokiomis sąlygomis: Nauji, jeigu reikia, patepti pjaustymo velenėliai, šaltas variklis, maitinimo vardinė įtampa ir vardinis dažnis (230V / 50Hz; 120V / 60Hz).

Nukrypstant nuo šių sąlygų lapų apdorojimo našumas gali būti mažesnis, o triukšmas veikiant prietaisui didesnis. Lapai tiekiami per vidurį ir išilgai, 90° kampu. Priklausomai į popieriaus savybių ir tiekimo, lapų apdorojimo našumas taip pat gali skirtis.

1.2 Saugos nuorodos

- Patikrinkite, ar jūsų elektros tinklo įtampa ir dažnis atitinka specifikacijų lentelėje nurodytus duomenis.
- Dokumentų smulkintuvo negalima statyti prie šilumos šaltinio!
- Įrenginį laikyti, gabenti ir naudoti leidžiama tik stačiai!
- Su įrenginiu leidžiama naudoti tik tuos skysčius ir dujas, kurie atitinka DAHLE taikytinas direktyvas!
- Įrenginio negalima atidaryti!
- Saugant pastato elektros tinklą nuo trumpųjų jungimų turi būti įrengtas maks. 16Asaugiklis (JAV maks. 20 A).
- Prietaisą leidžiama naudoti tik uždaroje patalpoje, esant 10–25 °C (50–77 °F) temperatūrai ir 15–94% oro drėgnei be kondensacijos!
- Nenaudokite tuščio įrenginio!
- Prietaisas nėra skirtas naudoti asmenims (įskaitant ir vaikus), kurių fiziniai, jutiminiai ar protiniai gebėjimai yra riboti, arba kuriems trūksta patyrimo ir žinių, išskyrus atvejus, kai jie dirba prižiūrimi arba už saugą atsakingas asmuo juos išsamiai instruktuoja, kaip naudotis prietaisu.



Dokumentų smulkintuvą utilizuokite techniniu požiūriu tinkamu ir aplinkai nekenksmingu būdu, t. y. atiduokite jį įgaliojamai atliekų tvarkymo įmonei. Dokumentų smulkintuvo dalių ir pakuotės neišmeskite su buitinėmis atliekomis.

1.3 Piktogramos



Svarbi informacija



Skaityti naudotojo informaciją/saugos instrukcijas



DĖMESIO



DĖMESIO! Elektros smūgio pavojus.



DĖMESIO, judančios dalys



DĖMESIO, aštrūs kraštai



Draudžiama naudoti aparatą šalia edžių medžiagų.



Įrenginį reikia stabiliai pastatyti ant grindų 100 mm atstumu nuo sienos, saugoti nuo įkaitimo pavojaus, įjungti stabdymo mechanizmą (priklauso nuo įrenginio tipo).



Nenaudoti netoli degių skysčių arba dujų.



Automatinis įjungimas



Statykite tik ant sauso pagrindo



Šis dokumentų smulkintuvus neskirtas naudoti vaikams (gaminys nėra žaislas).



Nelieskite popieriaus tiektuvo rankomis.



Nekiškite prie popieriaus tiektuvo drabužių!



Nekiškite prie popieriaus tiektuvo plaukų!



Nelaikykite arti aerozolių!



Prieš naikindami dokumentus pašalinkite sąvaržėles ir sąsagėles!



















Negalima naikinti diskelių!



Prieš atlikdami priežiūros darbus dokumentų smulkintuvą atjunkite nuo maitinimo šaltinio!



Techniniai duomenys - Galimi techniniai pakeitimai!

	Triukšmo lygis tuščiaja eiga		Elektros maitinimo lizdas turi būti visada lengvai pasiekiamas!		Techninės priežiūros / gedimų šalinimo instrukcijos
	Įtraukimo greitis		Valdymas		Prisip. dėžė
	Popieriaus smulkinimas juostelėmis		Įrenginys parengtas veikti		Galimos triktys
	Kortelių smulkinimas juostelėmis		Įrenginys naudojimo metu		Automatinis išjungimas, kai atidarytas dangtis
	Masė		Automatinis išjungimas!		
	Tinklo kištukas skirtas elektros maitinimo šaltiniui atjungti!		Ilgą naudojimo ir (arba) perkrovos atveju dokumentų smulkintuvas išsijungia automatiškai, kad atvėstų.		

lv Lietošanas norādījumi



UZMANĪBU!

Pirms sākat izmantot dokumentu smalcinātāju, lūdzam uzmanīgi izlasīt lietošanas pamācību un drošības norādes!

levērojiet drošības norādes!

Saglabājiēt lietošanas pamācību turpmāķai uzzīņai.



Satura rādītājs

1	Svarīga informācija	55
1.1	Paredzētais pielietojums un garantija	55
1.2	Drošības norādes	56
1.3	Paskaidrojumi par piktogrammām	56
1.4	Piegādes komplekts	88
1.5	Tehniskie dati	88
2	Lietošana	89
2.2	Ierīces pievienošana strāvas tīklam	89
2.3	Ierīces ieslēgšana	89
2.4	Dokumentu smalcināšana	90
2.10	Karšu smalcināšana	92
3	Apkope/traucējumu novēršana	93
3.1	Sasmalcinātās masas iztukšošana	93
3.3	Tvertne/vāks atvērts	93
3.4	Pārkaršana	94
3.6	Manuālās ievilkšanas papīra sastrēgums	94
3.8	Automātiskās ievilkšanas papīra sastrēgums	95
3.15	Ierīces tīrīšana	97

1.1 Paredzētais pielietojums un garantija

Dokumentu smalcinātājs ir paredzēts papīra sasmalcināšanai.

Daži ierīces modeļi var sasmalcināt arī nelielu tālāk norādīto materiālu daudzumu:

- CD/DVD, maksājumu kartes (skatiet sadaļu "Tehniskie dati");
- papīra dokumentos parastajā daudzumā ietvertās saspraudes un skavas (izņēmums: ierīces, kas atbilst drošības pakāpei P6 un P7).

Garantija neietver nodilumu, neprofesionālas lietošanas un trešās puses veiktu darbību dēļ radītos ierīces bojājumus.

Dokumentu smalcinātājs ir paredzēts lietošanai nekomerciālos nolūkos un parastā biroja vidē.

Uz tehniskajos datos norādīto lapu skaitu attiecas turpmākie robežnosacījumi:

Maksimālais lapu skaits, kas tiek sagrieztas vienā reizē ar šādiem nosacījumiem: jaunas un nepieciešamības gadījumā ieeļļotas griešanas velmes, auksts motors, nomināls barošanas spriegums un frekvence (230V/50 Hz; 120V/60 Hz).

Novirzes var samazināt apstrādāto lapu skaitu un palielināt ekspluatācijas trokšņus. Lapas tiek padotas centrēti un gareniski 90° leņķī. Apstrādāto lapu skaits var mainīties atkarībā no papīra īpašībām un padeves veida.

1.2 Drošības norādes

- Pārbaudiet, vai pieejamā strāvas tīkla spriegums un frekvence atbilst norādēm uz datu plāksnītes.
- Ierīci nedrīkst uzstādīt karstuma avota tuvumā!
- Ierīce ir jāglabā, jāpārvadā un jāizmanto tikai vertikālā stāvoklī!
- Ierīcē drīkst izmantot tikai tādus šķidrumus un gāzes, kas atbilst DAHLE vadlīnijām!
- Ierīci nedrīkst atvērt!
- Ēkas elektroinstalācija ir jānodrošina pret īsslēgumu: maks. 16 A (ASV maks. 20 A)!
- Ierīci drīkst izmantot tikai slēgtā telpā, kur gaisa temperatūra ir no 10 °C līdz 25 °C (no 50 °F līdz 77 °F) un kur gaisa mitrums no 15 % līdz 94 % neizraisa ūdens kondensāciju!
- Nepieļaujiet ierīces darbību tukšgaitā!
- Ierīci nedrīkst lietot personas (tostarp bērni) ar ierobežotām fiziskām, sensorām vai garīgām spējām vai nepietiekamu pieredzi un zināšanām, izņemot gadījumus, kad darbs tiek uzraudzīts vai par drošību atbildīgā persona ir veikusi visaptverošu apmācību par ierīces lietošanu.



Dokumentu smalcinātāju utilizējiet pareizā veidā – nododiet to apstiprinātā savākšanas punktā. Neizmetiet dokumentu smalcinātāja daļas vai tā iepakojumu kopā ar sadzīves atkritumiem.

1.3 Paskaidrojumi par piktogrammām



Svarīga informācija



Izlasīt paziņojumu lietotājam/drošības norādes



UZMANĪBU!



UZMANĪBU! Elektriskās strāvas trieciena risks.



UZMANĪBU, kustīgās daļas



UZMANĪBU, asas malas



Ierīces tuvumā nedrīkst atrasties kodīgas vielas.



Stabili uzstādīt ierīci uz grīdas 100 mm attālumā no sienas, nepieļaut siltuma uzkrāšanos ap ierīci, iedarbināt fiksēšanas mehānismu (atkarībā no ierīces veida)



Neizmantojiet vidē, kur tuvumā ir viegli uzliesmojoši šķidrums un gāzes.



Automātiska darbības uzsākšana



Sargāt no mitruma



Dokumentu smalcinātāju aizliegts lietot bērniem (šī ierīce nav rotaļlieta)!



Aizliegts ar rokām pieskarties papīra padeves vadotnei.



Nedrīkst pieļaut apģērba nonākšanu papīra padeves vadotnē!



Nedrīkst pieļaut matu nonākšanu papīra padeves vadotnē!



Sargāt no aerosoliem!



Pirms smalcināšanas izņemiet no dokumentiem skavas un noņemiet saspraudes!



















Aizliegts smalcināt datora disketes!



Pirms smalcinātāja apkopes darbu sākuma atvienojiet ierīci no elektriskā tīkla!



Tehniskie rādītāji - iespējamas tehniskas izmaiņas!

- | | | | | | |
|--|---|---|--|---|--|
|  | Darbības troksnis tukšgaitā |  | Elektriskā tīkla kontaktligzdai vienmēr ir jābūt brīvi pieejamai! |  | Apkopes norādījumi / darbības traucējumu novēršana |
|  | levilkšanas ātrums |  | Apkalpošana |  | Tvertne pilna |
|  | Papīra smalcināšana gabalos |  | Dokumentu smalcinātājs gatavs darbam |  | Iespējamie traucējumi |
|  | Karšu smalcināšana gabalos |  | Dokumentu smalcinātājs darbojas |  | automātiski izslēdzas, kad atver korpusu |
|  | Svars |  | Automātiska izslēgšana! | | |
|  | Tīkla kontaktspraudnis kalpo kā elektriskās strāvas padeves pārtraukšanas ierīce. |  | Ilgākas darbināšanas vai pārslodzes gadījumā dokumentu smalcinātājs automātiski izslēdzas, lai atdzistu. | | |



cs Návod k použití



UPOZORNĚNÍ!

Návod k obsluze a bezpečnostní pokyny ke skartovacímu zařízení si pozorně přečtěte PŘED jeho uvedením do provozu.

Dodržujte uvedené pokyny!

Návod k obsluze uchovejte pro případ pozdější potřeby.



Obsah

1	Důležité informace	58
1.1	Účelové použití, ručení	58
1.2	Bezpečnostní ustanovení	59
1.3	Popis piktogramů	59
1.4	Rozsah dodávky	88
1.5	Technické údaje	88
2	Obsluha	89
2.2	Připojení přístroje k elektrické síti	89
2.3	Zapnutí přístroje	89
2.4	Skartování papíru	90
2.10	Skartování karet	92
3	Údržba / odstraňování závad	93
3.1	Vyprázdnění rozřezaného materiálu	93
3.3	Otevřený zásobník / otevřené víko	93
3.4	Přehřátí	94
3.6	Uvíznutý papír v ručním podávání	94
3.8	Uvíznutý papír v automatickém vtahování	95
3.15	Vyčistěte přístroj	97

1.1 Účelové použití, ručení

Skartovací zařízení je určeno ke skartování papíru.

V závislosti na modelu je však možné skartovat také malá množství následujících materiálů:

- CD/DVD disky, šekové a kreditní karty (viz technické údaje).
- kancelářské sponky a drátky, které se nacházejí v papírových dokumentech v běžném množství (výjimka: zařízení bezpečnostního stupně P6 a P7).

Přístroj je vybaven automatickým vtahováním stohu papíru, který obsahuje nepřehnuté jednotlivé listy (max. Na opotřebení, poškození způsobené nevhodným používáním, stejně jako zásahy třetí strany, se nevztahuje ručení ani záruka.

Skartovací zařízení je koncipováno pro provoz v soukromém sektoru a v běžném kancelářském prostředí.

Kapacita skartace uvedená v technických údajích podléhá následujícím podmínkám:

Maximální počet současně skartovaných listů za následujících podmínek: Nové případně naolejované řezné válce, studený motor, napájení proudem při jmenovitých hodnotách napětí a frekvence (230V/50Hz, 120V/60Hz).

Odchytky mohou vést ke snížení kapacity skartace a ke zvýšenému hluku. Listy se vkládají doprostřed a podélně pod 90° uhlím. V závislosti na vlastnostech a podávání papíru se kapacita skartace může také lišit.

1.2 Bezpečnostní upozornění

- Přesvědčte se, zda napětí a kmitočety vaší elektrické sítě souhlasí s údaji na typovém štítku.
- Zařízení neumísťujte do blízkosti zdrojů tepla!
- Zařízení skladujte, přepravujte a provozujte pouze v poloze ve stoje.
- Na zařízení používejte pouze kapaliny a plyny odpovídající směrnícím společnosti DAHLE.
- Zařízení nikdy neotvírejte!
- Zajistěte ochranu instalace v budově proti zkratu: max. 16 A (USA max. 20 A).
- Provozujte zařízení výhradně v uzavřených místnostech při teplotě 10 °C až 25 °C (50 °F až 77 °F) a při nekondenzující vlhkosti vzduchu od 15 % do 94 %!
- Zařízení nenechávejte běžet naprázdno!
- Zařízení není určeno k používání osobami (včetně dětí) s omezenými fyzickými, smyslovými nebo duševními schopnostmi nebo s nedostatečnými zkušenostmi a znalostmi, pokud nepracují pod dohledem nebo pokud se jim nedostane podrobného návodu k používání přístroje od osoby odpovědné za bezpečnost.



Skartovací zařízení nechte ekologicky a odborně zlikvidovat autorizovanou sběrnou. Nevyhazujte žádné díly skartovače nebo balení do domácího odpadu.

1.3 Popis piktogramů

- | | | | | | |
|--|--|---|--|---|--|
|  | Důležitá informace |  | Nepoužívejte zařízení v blízkosti hořlavých kapalin nebo plynů. |  | Kancelářské sponky a sponky ze sešivaček před skartováním odstranit! |
|  | Přečtěte si informace pro uživatele/bezpečnostní pokyny |  | Automaticky rozběh |  | Ne vkládejte žádné diskety! |
|  | POZOR |  | Nepoužívejte ve vlhkém prostředí |  | Před prováděním údržby skartovač odpojit od přívodu proudu! |
|  | POZOR! Nebezpečí úrazu elektrickým proudem. |  | Toto skartovací zařízení není určeno pro děti (tento produkt není hračka). |  | Technické údaje — Technické změny vyhrazeny! |
|  | POZOR, pohyblivé části |  | Otvor pro vstup papíru se nedotýkejte rukama. |  | Provozní hlukčnost při chodu naprázdno |
|  | POZOR, ostré hrany |  | Zabraňte styku přívodu papíru s oblečením! |  | Rychlost vtahování |
|  | Nepoužívejte zařízení v blízkosti žíravých látek. |  | Pozor, aby se do vstupu pro papír nedostaly vlasy! |  | Řezání papíru na kusy |
|  | Zařízení umístěte stabilně na podlahu s odstupem 100 mm ode zdi, tím zabráníte kumulaci tepla, zablokujte brzdy na kolečkách (podle typu zařízení) |  | Uchovávejte spreje z dosahu přístroje! |  | Řezání karet na kusy |

- | | | | | | |
|--|--|--|--|--|--|
| | Hmotnost | | Skartovač v provozní pohotovosti | | Pokyny pro údržbu/odstraňování závad |
| | Síťová zástrčka slouží jako dělicí zařízení od napájení ze sítě. | | Skartovač v provozu | | Zásobník plný |
| | Síťová zástrčka musí být vždy snadno přístupná! | | Automatické vypínání! | | Možné poruchy |
| | Obsluha | | Při delším provozu a/nebo při přetížení se skartovací zařízení automaticky vypne, dokud nevychladne. | | automatické vypnutí při otevření krytu |

sk **Návod na použitie**



POZOR!

PRED uvedením skartovacieho prístroja do prevádzky si pozorne prečítajte návod na obsluhu a bezpečnostné pokyny.



Pokyny sa musia aplikovať!

Návod na obsluhu si uschovajte na neskoršie použitie.

Obsah

1	Dôležité informácie	61
1.1	Použitie v súlade s určeným účelom, záruka	61
1.2	Bezpečnostné pokyny	62
1.3	Legenda piktogramov	62
1.4	Rozsah dodávky	88
1.5	Technické údaje	88
2	Obsluha	89
2.2	Pripojenie zariadenia k elektrickej sieti	89
2.3	Zapnutie prístroja	89
2.4	Skartácia papiera	90
2.10	Skartácia kariet	92
3	Údržba / odstraňovanie porúch	93
3.1	Odstránenie skartovaného materiálu	93
3.3	Otvorená nádrž / otvorený poklop	93
3.4	Prehriatie	94
3.6	Zaseknutie papiera pri ručnom vkladaní	94
3.8	Zaseknutie papiera pri automatickom vťahovaní	95
3.15	Čistenie prístroja	97

1.1 **Použitie zariadenia v súlade s určeným účelom, poskytnutie záruky**

Skartovací prístroj je určený na skartovanie papiera. Podľa variantu modelu je možné okrem toho skartovať malé množstvá nasledujúcich materiálov:

- CD/DVD disky, šekové a kreditné karty (pozri technické údaje).
- spinky a kancelárske spony nachádzajúce sa v papierových dokumentoch, v obvykle používanom rozsahu (výnimka: prístroje stupňa bezpečnosti P6 a P7).

Ručenie ani záruka sa nevzťahuje na opotrebovanie, škody spôsobené neodborným používaním ani zásahy tretej strany

Skartovací prístroj je koncipovaný pre prevádzku v súkromí a v bežnom kancelárskom prostredí.

Na základe kapacity skartácie uvedenej v technických údajoch platia nasledovné rámcové podmienky: Maximálny počet listov, ktoré je možné rezať naraz, v prípade dodržania nasledovných podmienok: Nové, resp. naolejované rezacie valce, studený motor, napájací prúd s menovitým napätím a menovitou frekvenciou (230V/50Hz, 120V/60Hz).

Odchýlky môžu mať za následok zníženie kapacity skartácie a zvýšenie hlučnosti chodu. Listy sú vedené stredom a po dĺžke pod uhlom 90°. V závislosti od vlastností papiera a prívodu sa môže sa môže kapacita skartácie odlišovať.

1.2 Bezpečnostné pokyny

















- Skontrolujte, či napätie a frekvencia v elektrickej sieti zodpovedá údajom na typovom štítku.
- Neinštalujte prístroj v blízkosti tepelného zdroja!
- Prístroj skladujte, prepravujte a prevádzkujte iba nastojato!
- Na prístroji používajte iba kvapaliny a plyny, ktoré zodpovedajú smerniciam spoločnosti DAHLE!
- Prístroj sa nesmie otvárať!
- Prístroj neprevádzkujte v chode naprázdno!
- Prístroj prevádzkujte iba v uzavretých priestoroch, pri 10 °C až 25 °C (50 °F do 77 °F) a nekondenzujúcej vlhкости vzduchu od 15 % do 94 %!
- Zabezpečte ochranu pred skratom na inštalácii v budove: max. 16A (US max. 20A).
- Zavádzače papiera používajte iba jednotlivito!
- Prístroj nie je určený pre používanie osobami (vrátane detí) s obmedzenými fyzickými, zmyslovými alebo duševnými schopnosťami alebo nedostatočnými skúsenosťami a vedomosťami, jedine s výnimkou, ak pri používaní prístroja pracujú pod dozorom alebo výlučným vedením osoby, ktorá zodpovedá za bezpečnosť.



Skartovací prístroj zlikvidujte odborne a ekologicky na autorizovanom zbernom mieste. Žiadne časti skartovacieho prístroja alebo balenia nezahadzujte do domáceho odpadu.

1.3 Legenda piktogramov

- | | | | | | |
|--|--|---|--|---|---|
|  | Dôležitá informácia |  | Prístroj stabilne nainštalujte na podlahu a vo vzdialenosti 100 mm od steny, zabráňte hromadeniu tepla, Stlačte ručné brzdy (v závislosti od typu) |  | Otvoru prívodu papiera sa nedotýkajte odevom! |
|  | Prečítajte si informáciu pre používateľa/bezpečnostné pokyny |  | Nepoužívať v blízkosti horľavých kvapalín alebo plynov. |  | Otvoru prívodu papiera sa nedotýkajte vlasmi! |
|  | POZOR |  | Automatický rozbeh |  | Do blízkosti neukladajte plechovky so sprejmi! |
|  | POZOR! Nebezpečenstvo úrazu elektrickým prúdom. |  | Nevystavujte vlhkosti |  | Pred skartovaním odstráňte z dokumentov kancelárske spinky a spony! |
|  | POZOR, pohyblivé časti |  | Tento skartovací prístroj nie je určený na používanie deťmi (výrobok nie je hračka). |  | Nezasúvajte žiadne disky! |
|  | POZOR, ostré hrany |  | Otvoru prívodu papiera sa nedotýkajte rukami! |  | Pred údržbárskymi prácami odpojte skartovací prístroj od napájacieho prúdu! |
|  | Nepoužívať v blízkosti žieravých látok. |  | | | Technické údaje — Technické zmeny vyhradené! |

- | | | | | | |
|--|---|---|---|---|---|
|  | Prevádzková hlasitosť pri chode naprázdno |  | Sieťová zásuvka musí byť vždy ľahko prístupná! |  | Pokyny na údržbu/odstraňovanie porúch |
|  | Rýchlosť vťahovania |  | Obsluha |  | Nádoba je plná |
|  | Priečny rez papiera |  | Skartovací prístroj v pohotovostnom stave |  | Možné poruchy |
|  | Priečny rez karty |  | Skartovací prístroj v prevádzke |  | automatické vypnutie pri otvorení kryty |
|  | Hmotnosť |  | Automatické vypnutie! | | |
|  | Sieťová zástrčka slúži na oddelenie od napájania. |  | Pri dlhšej prevádzke a/alebo preťažení sa skartovací prístroj automaticky vypne, aby vychladol. | | |



pl Instrukcja użytkowania



UWAGA!

PRZED uruchomieniem niszczarki należy uważnie przeczytać instrukcję obsługi oraz wskazówki bezpieczeństwa.



Należy przestrzegać wskazówek! Instrukcję obsługi należy zachować do późniejszego użytku.

Spis treści

1	Ważne informacje.....	64
1.1	Użytkowanie zgodne z przeznaczeniem, gwarancja.....	64
1.2	Wskazówki bezpieczeństwa.....	65
1.3	Objaśnienie symboli.....	65
1.4	Zakres dostawy.....	88
1.5	Dane techniczne.....	88
2	Obsługa.....	89
2.2	Podłączanie urządzenia do sieci elektrycznej.....	89
2.3	Włączanie urządzenia.....	89
2.4	Niszczanie dokumentów.....	90
2.10	Niszczanie kart.....	92
3	Konserwacja/usuwanie usterek.....	93
3.1	Opróżnianie niszczarki.....	93
3.3	Pojemnik lub pokrywa są otwarte.....	93
3.4	Przegrzanie.....	94
3.6	Zator papieru, podajnik ręczny.....	94
3.8	Zator papieru, podajnik automatyczny.....	95
3.15	Czyszczenie urządzenia.....	97

1.1 Użytkowanie zgodne z przeznaczeniem, gwarancja

Niszczarka jest przeznaczona do niszczenia papieru. W zależności od modelu niszczarki można ją ponadto wykorzystać do niszczenia w niewielkich ilościach następujących materiałów:

- płyt CD/DVD, kart bankomatowych i kredytowych (patrz dane techniczne).
- występujących w zwykłym zakresie w dokumentach papierowych zszywek i spinaczy biurowych (wyjątek: urządzenia stopnia bezpieczeństwa P6 i P7).

Zużycie, szkody na skutek nieprawidłowego użycia oraz ingerencji osób trzecich nie są objęte ani rękojmią ani gwarancją.

Ta niszczarka dokumentów jest przeznaczona do użytku prywatnego oraz w normalnych warunkach biurowych.

Wydajność niszczarki podana w danych technicznych podlega następującym warunkom ogólnym: Maksymalna ilość kartek, która może zostać zniszczona w jednej turze w następujących warunkach: Nowe, ewentualnie naoliwione walce tnące, zimny silnik, zasilanie elektryczne z napięciem znamionowym i częstotliwością znamionową (30V/50Hz; 120V/60 Hz).

Odstępstwa mogą prowadzić do zmniejszonej wydajności i do głośniejszej pracy. Kartki należy wkładać na środku, wzdłuż, pod kątem 90°. Wydajność może być zmienna również zależnie od rodzaju papieru i sposobu wprowadzania go.

1.2 Wskazówki bezpieczeństwa

















- Sprawdzić, czy napięcie i częstotliwość sieci zgadzają się z danymi na tabliczce znamionowej.
- Urządzenia nie ustawiać w pobliżu źródeł ciepła!
- Urządzenie składować, transportować i użytkować wyłącznie w pozycji pionowej!
- W urządzeniu stosować wyłącznie ciecze i gazy spełniające wytyczne DAHLE!
- Urządzenia nie wolno otwierać!
- Nie użytkować urządzenia na pusto!
- Urządzenie wolno użytkować wyłącznie w zamkniętych pomieszczeniach w temperaturze od 10 °C do 25 °C (50 °F do 77 °F) oraz przy nieskrapającym się powietrzu o wilgotności od 15 % do 94 %!
- Należy zapewnić zabezpieczenie przeciwzwarceniowe w instalacji budynku: maks. 16 A(US maks. 20A).
- Z podajników korzystać tylko pojedynczo!
- To urządzenie nie jest przeznaczone do użytku przez osoby (wraz dziećmi) z ograniczonymi zdolnościami fizycznymi, sensorycznymi lub umysłowymi lub z brakuującym doświadczeniem i wiedzą. Chyba, że pracują one pod nadzorem i otrzymują pełne instrukcje odnośnie korzystania z urządzenia od osoby odpowiedzialnej za bezpieczeństwo.



Niszczarkę usunąć w sposób nieszkodliwy dla środowiska przekazując do autoryzowanego punktu zbiórki. Żadnych elementów niszczarki lub jej opakowania nie wolno wyrzucać wraz z odpadami z gospodarstw domowych.

1.3 Objaśnienie symboli

- | | | | | | |
|--|--|--|---|--|--|
| | Ważne informacje | | Niszczarkę ustawić na stabilnym podłożu w odległości 100 mm od ściany, unikać zatorów cieplnych, uruchomić hamulec postojowy (w zależności od typu) | | Podajnika papieru nie wolno dotykać częściami garderoby! |
| | Przeczytać informacje dla użytkownika/wskazówki bezpieczeństwa | | Urządzenia nie wolno użytkować w pobliżu palnych cieczy lub gazów. | | Podajnika papieru nie wolno dotykać włosami |
| | UWAGA | | Automatyczny rozruch | | Trzymać z dala puszek ze sprayem! |
| | UWAGA! Ryzyko porażenia prądem. | | Chronić urządzenie przed wilgocią | | Spinacze biurowe oraz zszywki usunąć przed przystąpieniem do niszczenia dokumentu! |
| | UWAGA, części ruchome | | Z niszczarki nie wolno korzystać dzieciom (produkt nie jest zabawką). | | Nie wkładać dyskietek! |
| | UWAGA, ostre krawędzie | | Podajnika papieru nie wolno dotykać rękami! | | Przed przystąpieniem do prac konserwacyjnych odłączyć niszczarkę od zasilania! |
| | Urządzenia nie wolno użytkować w pobliżu substancji żrących | | | | Dane techniczne - Zmiany techniczne zastrzeżone! |

- | | | | | | |
|--|---|---|--|---|--|
|  | Głośność pracy na pusto |  | Gniazdko sieciowe musi być w każdej chwili łatwo dostępne! |  | Wskazówki konserwacyjne / Usuwanie usterek |
|  | Prędkość wciągania |  | Obsługa |  | Pełny pojemnik |
|  | Ścinki papieru |  | Niszczarka gotowa do pracy |  | Możliwe zakłócenia |
|  | Ścinki kart |  | Niszczarka pracuje |  | Automatyczne wyłączenie w przypadku otwarcia obudowy |
|  | Ciężar |  | Automatyczne wyłączenie! | | |
|  | Wtyczka sieciowa służy do odłączania zasilania. |  | Niszczarka wyłącza się automatycznie po dłuższym czasie pracy i/lub w razie przeciążenia w celu ostygnięcia. | | |

ro Instrucțiuni de utilizare



ATENȚIE!

Înainte de punerea în funcțiune a distrugătorului de documente, citiți cu atenție instrucțiunile de utilizare și indicațiile privind siguranța!



Normele de siguranță trebuie aplicate! Păstrați instrucțiunile pentru a le putea consulta ulterior.

Cuprins

1	Informații importante	67
1.1	Utilizarea conform destinației prevăzute, garanția standard	67
1.2	Indicații privind siguranța	68
1.3	Legenda pictogramelor	68
1.4	Pachetul de livrare	88
1.5	Date tehnice	88
2	Utilizare	89
2.2	Conectați dispozitivul la rețeaua de curent	89
2.3	Cuplați dispozitivul	89
2.4	Distrugerea hârtiei	90
2.10	Distrugerea de carduri	92
3	Întreținerea/remedierea defecțiunilor	93
3.1	Evacuarea materialului tocat	93
3.3	Decipientului/capacului deschis	93
3.4	Supraîncălzirea	94
3.6	Blocajul hârtiei la alimentarea manuală	94
3.8	Blocajul hârtiei la alimentarea automată	95
3.17	Curățarea dispozitivului	97

1.1 Utilizarea conform destinației prevăzute, garanția standard

Distrugătorul de documente este conceput pentru distrugerea hârtiei.

În funcție de model, în afară de hârtie pot fi distruse și alte materiale în cantitate redusă, cum ar fi:

- CD-uri/DVD-uri, cecuri și carduri bancare (consultați secțiunea Date tehnice).
- clemele de capsator și agrafele de birou care se află în documente, în cantitate uzuală (excepție: aparatele din clasa de siguranță P6 și P7).

Uzura și deteriorările cauzate de utilizarea neadecvată și de intervențiile terților asupra dispozitivului nu fac obiectul garanției standard sau al garanției extinse.

Distrugătorul de documente este conceput pentru utilizarea în zona privată și în mediile de birou obișnuite. Cu privire la numărul de coli specificat în datele tehnice se aplică următoarele condiții generale:

Numărul maxim de coli tăiate într-o singură fază poate fi asigurat în următoarele condiții: Rotoare de tăiere noi sau lubrifiate recent, motor rece, alimentare cu curent electric cu tensiune nominală și frecvență nominală de (230V/50 Hz, 120V/60 Hz).

Eventualele abateri de la acești parametri pot duce la o performanță mai scăzută față de numărul de coli specificat și la un nivel de zgomot în funcționare mai ridicat. Colile trebuie să fie introduse central și longitudinal, în unghi de 90°. De asemenea, performanța privind numărul de coli poate fi influențată și de proprietățile hârtiei și de modul în care se face alimentarea cu materiale.



1.2 Indicații privind siguranța

- Verificați dacă tensiunea și frecvența rețelei de alimentare cu curent corespund cu datele de pe plăcuța cu caracteristici a dispozitivului.
- Nu amplasați dispozitivul în apropierea unei surse de căldură!
- Depozitați, transportați și utilizați dispozitivul numai în poziție verticală!
- Utilizați pentru distrugătorul de documente numai lichide și gaze conforme cu reglementările DAHLE!
- Dispozitivul nu trebuie deschis!
- Utilizarea dispozitivului este permisă numai în spații închise, la temperaturi cuprinse între 10 °C și 25 °C (50 °F și 77 °F) și la o umiditate atmosferică fără condensare cuprinsă între 15% și 94%!
- Protecția la scurtcircuit a instalației electrice a clădirii trebuie să fie asigurată: max. 16A(SUA max. 20A).
- Nu lăsați distrugătorul de documente să funcționeze în gol!
- Aparatul nu este conceput pentru a fi utilizat de persoane (inclusiv copii) cu capacități fizice, senzoriale sau mentale limitate ori cu experiență și cunoștințe reduse, cu excepția situațiilor în care lucrează sub supraveghere sau sunt îndrumate în permanență în utilizarea aparatului de către o persoană care răspunde pentru siguranță.



Eliminați distrugătorul de documente în mod corect și ecologic, la un centru autorizat de colectare a deșeurilor. Nu aruncați componente ale distrugătorului de documente sau ale ambalajului la gunoierul menajer.

1.3 Legenda pictogramelor



Informație importantă



Consultați informațiile pentru utilizatori/instrucțiunile privind siguranța



Atenție



ATENȚIE! Pericol de electrocutare.



ATENȚIE, piese mobile



ATENȚIE, muchii ascuțite



A nu se utiliza în apropierea substanțelor corozive.



Amplasați dispozitivul în poziție stabilă la nivelul solului și la o distanță de 100 mm față de perete, evitați acumularea de căldură, Acționarea frânelor de blocare (în funcție de tip)



A nu se utiliza în apropierea lichidelor și a gazelor inflamabile.



Pornire automată



A nu se expune la umezeală



Distrugătorul de documente nu este conceput pentru a fi utilizat de copii (produsul nu este un obiect de joacă).



Nu atingeți fanta pentru intrarea hârtiei cu mâinile.



Nu atingeți fanta pentru intrarea hârtiei cu obiecte de îmbrăcăminte!



Nu atingeți fanta pentru intrarea hârtiei cu părul!



Țineți la distanță tuburile de spray!



Îndepărtați capsele și clemele de hârtie înainte de distrugerea documentelor!



















Nu introduceți dischete!



Înainte de executarea lucrărilor de întreținere, deconectați dispozitivul de la alimentarea cu curent!



Date tehnice - Rezervat dreptul de a efectua modificări tehnice!

- | | | |
|---|--|---|
|  <p>Nivelul de zgomot la funcționarea în gol</p> |  <p>Utilizare</p> |  <p>Recipient plin</p> |
|  <p>Viteză de tragere în interior</p> |  <p>Distrugătorul de documente pregătit de funcționare</p> |  <p>Avarii posibile</p> |
|  <p>Tăierea în particule a hârtiei</p> |  <p>Distrugătorul de documente în funcțiune</p> |  <p>Aparatul se oprește automat atunci când este deschis</p> |
|  <p>Tăierea în particule a cardurilor</p> |  <p>Oprire automată!</p> | |
|  <p>Greutate</p> |  <p>În cazul unei funcționări mai îndelungate și/sau în caz de suprasarcină, distrugătorul de documente se oprește automat în scop de răcire.</p> | |
|  <p>Ștecherul servește ca dispozitiv de deconectare de la alimentarea cu curent electric!</p> |  <p>Instrucțiuni pentru lucrări de întreținere / remediarea defecțiunilor</p> | |
|  <p>Priza de alimentare cu curent electric trebuie să fie facil accesibilă în orice moment!</p> | | |



bg Указание за употреба



ВНИМАНИЕ!
ПРЕДИ пускане в експлоатация на машината за унищожаване на документи, прочетете ръководството за употреба и препоръките за безопасност.
Указанията трябва да се прилагат!
Съхранявайте ръководството за бъдеща употреба.



Съдържание

1	Важна информация	70
1.1	Използване по предназначение, гаранция	70
1.2	Указания за безопасност	71
1.3	Легенда на пиктограмите	71
1.4	Окомплектовка на доставката	88
1.5	Технически данни	88
2	Обслужване	89
2.2	Свързване на уреда към електрическата мрежа	89
2.3	Включване на уреда	89
2.4	Унищожаване на хартия	90
2.10	Унищожаване на карти	92
3	Поддръжка/отстраняване на неизправности	93
3.1	Изправване на изрезките	93
3.3	Отворен съд/капак	93
3.4	Прегряване	94
3.6	Задръстване на хартия ръчно подаване	94
3.8	Задръстване на хартия автоматично подаване	95
3.15	Почистване на уреда	97

1.1 Използване по предназначение, гаранция

Машината за унищожаване на документи е предназначена за унищожаване на хартия.

В зависимост от варианта на модела, освен това могат да се унищожават минимални количества от следните материали:

- CD/DVD, платежни и кредитни карти (виж Технически данни).
- телчета и кламери в количеството, обичайно за приложението им в хартиени документи (изключение: уреди с ниво на сигурност P6 и P7).

Износване, повреди поради некомпетентна употреба, както и намеси на трети лица, не попадат под гаранцията.

Машината за унищожаване на документи е разработена за частна употреба и нормална офис среда.

По отношение на посочената в техническите данни производителност в листове важат следните рамкови условия:

Максимален брой листове, които се режат при едно преминаване при следните условия: Нови, респ. смазани режещи валяци, студен двигател, електрозахранване с номинално напрежение и номинална честота (230 V/50 Hz; 120 V/60 Hz).

Отклоненията може да доведат до по-ниска производителност в листове и до увеличени шумове при рязане. Листите се подават в средата и надлъжно под 90°. В зависимост от характеристиките на хартията и подаването е възможно производителността в листи също да варира.

1.2 Указания за безопасност

- Проверете дали напрежението и мрежовата честота на Вашата електрозахранваща мрежа съответстват на данните на типовата табелка.
- Указания за безопасност
- Уредът да не се поставя в близост до източник на топлина!
- Уредът да се складира, транспортира и експлоатира само в изправено положение!
- В уреда да се използват само течности и газове, които съответстват на директивите на DAHLE!
- Не се допуска отварянето на уреда!
- Уредът да се експлоатира само в затворени помещения, при 10°C до 25°C (50°F до 77°F) и некондензираща въздушна влажност от 15% до 94%!
- Трябва да се гарантира безопасността на инсталацията на сградата при късо съединение: макс. 16А (САЩ макс. 20А).

















- Уредът да не се експлоатира на празен ход!
- Уредът не е предназначен за използване от лица (включително деца) с ограничени психични, сетивни или умствени способности или недостатъчен опит и знания, освен ако работят под надзор или са получили подробен инструктаж за използването на уреда от лице, което отговаря за безопасността.



Изхвърляйте машината за унищожаване на документи компетентно и екологично в оторизиран събирателен пункт. Не изхвърляйте части от машината за унищожаване на документи или от опаковката с битовата смет.

1.3 Легенда на пиктограмите

	Важни информации		Уредът да се постави стабилно на пода и на разстояние от 100 mm от стената, да се избягва акумулиране на топлина, Задействане на застопоряващите спиратки (в зависимост от типа)		Не докосвайте с ръце подаването на хартията.
	Да се прочете информацията за потребителя/препоръките за безопасност		Да не се използва в близост до горими течности или газове.		Не докосвайте с части от облеклото подаването на хартията!
	ВНИМАНИЕ		Автоматично пускане		Не докосвайте с косите подаването на хартията!
	ВНИМАНИЕ! Риск от токов удар.		Да не се излага на влага		Дръжте далеч флакони със спрей!
	ВНИМАНИЕ, движещи се части		Тази машина за унищожаване на документи не е предназначена за използване от деца (продуктът не е играчка).		Кламерите да се отстраняват преди процеса на унищожаване!
	ВНИМАНИЕ, остри ръбове				Не вкарвайте дискети!
	Да не се използва в близост до разяждащи вещества.				Преди работи по поддръжката, машината за унищожаване на документи да се изключи от електрозахранването!

	Технически данни - запазено правото за технически промени!		Мрежовият контакт трябва по всяко време да е лесно достъпен!		Контейнер пълен
	Работен шум на празен ход		Употреба		Възможни неизправности
	Скорост на поемане		Машина за унищожаване на документи в готовност		автоматично изключване при отворен корпус
	Рязане на хартията на частици		Машина за унищожаване на документи при работа		
	Рязане на карти на частици		Автоматично изключване!		
	Тегло		При по-дълга експлоатация и/или претоварване, машината за унищожаване на документи се изключва автоматично за охлаждане.		
	Мрежовият щепсел служи за разделящо устройство на електрохранването.		Указания за поддръжка / отстраняване на неизправности		

tr Kullanım kılavuzu



DİKKAT!

Dosya yok edicisini çalıştırmadan ÖNCE kullanım kılavuzunu ve güvenlik uyarılarını dikkatle okuyun.



Uyarılar uygulanmalıdır!

Kullanım kılavuzunu bir başvuru kaynağı olarak dikkatle muhafaza edin.

İçindekiler

1	Önemli Bilgiler	73
1.1	Amacına Uygun Kullanım, Garanti	73
1.2	Güvenlik Uyarıları	74
1.3	Piktogram Açıklaması	74
1.4	Teslimat Kapsamı	88
1.5	Teknik Veriler	88
2	Kullanım	89
2.2	Cihazı Güç Kaynağına Bağlama	89
2.3	Cihazı Çalıştırma	89
2.4	Kağıt İmhası	90
2.10	Kart İmhası	92
3	Bakım / Arıza Giderme	93
3.1	Kesilen Atıkları Boşaltma	93
3.3	Hazne/Kapak Açık	93
3.4	Aşırı Isınma	94
3.6	Kağıt Yığınının Manuel Olarak İçeri Çekme	94
3.8	Kağıt Yığınının Otomatik İçeri Çekme	95
3.15	Cihazı Temizleme	97

1.1 Amacına uygun kullanım, garanti

Dosya yok edicisi kağıtların imha edilmesi için tasarlanmıştır.

Model türüne göre ayrıca aşağıdaki maddelerden az miktarda imha edilebilir:

- CD'ler/DVD'ler, çek ve kredi kartları (Teknik Verilere bakın).
- kağıt dokümanlarda, normal kapsamda mevcut ataçlar (İstisna: P6 ve P7 emniyet kademesi cihazlar).

Aşınma, amacının dışında kullanım sonucu oluşan hasarlar ve üçüncü şahısların müdahaleleri garanti kapsamına girmezler

Dosya yok edicisi kişisel kullanım ve normal büro ortamı için tasarlanmıştır.

Teknik bilgiler doğrultusunda belirtilen sayfa performansı ile ilgili olarak aşağıdaki çerçeve koşullar geçerlidir:

Bir geçişte aşağıdaki koşullar altında kesilen maksimum sayfa sayısı: Yeni, gerekirse yağlanmış kesme merdaneleri, soğuk motor, nominal gerilimi ve nominal frekansı ile elektrik beslemesi (230V/50 Hz; 120V/60 Hz).

Sapmalar daha düşük bir sayfa performansına ve daha yüksek çalışma gürültüsüne yol açabilir. Sayfalar ortalanarak ve uzunlamasına 90°'lik açıyla beslenir. Kağıt özelliklerine ve beslemeye göre sayfa performansı değişebilir.

1.2 Güvenlik uyarıları

- Kullandığınız şebeke elektriğinin voltajının ve frekansının tip plakasındaki bilgilerle aynı olmasını kontrol edin.
- Cihazı, ısı kaynağının yakınına monte etmeyin!
- Cihazı sadece dik şekilde depolayın, taşıyın ve çalıştırın!
- Cihazda yalnızca DAHLE yönergelerine uygun sıvılar ve gazlar kullanın!
- Cihaz açılmamalıdır!
- Cihazı sadece kapalı mekanlarda, 10 C ile 25 C (50 °F - 77 °F) arasındaki sıcaklıklarda %15 ile %94 arasındaki yoğunlaşmayan hava nemliliğinde çalıştırın!
- Bina tesisatının kısa devre yapmaması sağlanmalıdır: maks. 16 A (US maks. 20A).
- Cihazı boшта çalıştırmayın!
- Cihaz fiziksel, sensörel veya ruhsal yetenekleri sınırlı veya yeterli deneyime ve bilgiye sahip olmayan kişiler (çocuklar dahil) tarafından kullanılmamalıdır. Buna sadece gözetim altında oldukları zaman veya güvenliğinden sorumlu bir kişi tarafından cihazın kullanımı ayrıntılı olarak anlatılırsa izin verilir.



Dosya yok edicisini teknolojiye ve çevreye uygun bir şekilde yetkili bir toplama yerinde imha edin. Dosya yok edicisinin parçalarını veya ambalajını ev çöpüne atmayın.

1.3 Piktogram açıklaması



Önemli bilgi



Kullanıcı bilgisi/güvenlik uyarılarını okuyun



DİKKAT



DİKKAT! Elektrik çarpması riski.



DİKKAT, hareketli parçalar



DİKKAT, keskin kenarlar



Aşındırıcı maddelerin yakınında kullanmayın.



Cihazı güvenli duracak şekilde ve duvara 100 mm mesafede kurun, ısı birikmesini önleyin, Sabitleme frenlerini devreye alın (tipe bağlı)



Yanıcı sıvıların ve gazların yakınında kullanmayın.



Otomatik çalışma



Islaklığa maruz bırakmayın



Bu dosya yok edicisi çocuklar tarafından kullanılmak üzere tasarlanmamıştır (ürün, oyuncak değildir).



Kağıt beslemesine ellerinizle dokunmayın.



Kağıt beslemesine elbiseleriniz değmemelidir!



Kağıt beslemesine saçlarınızla dokunmayın!



Sprey kutularını uzak tutun!



Yok etmeden önce kısıkaçları ve ataçları çıkarın!



Disket yerleştirmeyin!



Bakım çalışmalarından önce dosya yok edicisini elektrik beslemesinden ayırın!



Teknik veriler - Teknik değişiklik yapma hakkı saklıdır!



Boşta çalışırken çalışma sesi



Çekme hızı



Kağıt partikül kesim



Kart partikül kesim



Ağırlık



Fiş, elektrik kaynağından ayırma tertibatı olarak kullanılır.



Elektrik prizi her an için erişilir olmalıdır!



Kullanım



Dosya yok edicisi hazır



Dosya yok edicisi çalışıyor



Otomatik kapatma!



Uzun süreli işletimde ve/veya aşırı yüklenme durumunda dosya yok edicisi otomatik olarak soğumak için kapanır.



Bakım bilgileri/arıza giderme



Hazne dolu



Olası arızalar



Gövde açık iken otomatik kapanma



e1 Οδηγίες χρήσης



ΠΡΟΣΟΧΗ!

ΠΡΙΝ από την έναρξη λειτουργίας του καταστροφέα εγγράφων διαβάξτε προσεκτικά το εγχειρίδιο χρήσης και τις υποδείξεις ασφαλείας.

Πρέπει να τηρούνται οι υποδείξεις!

Το εγχειρίδιο χρήσης πρέπει να φυλάσσεται για μεταγενέστερη χρήση.



Πίνακας περιεχομένων

1	Σημαντικές πληροφορίες	76
1.1	Ενδεειγμένη χρήση, παροχές εγγύησης	76
1.2	Υποδείξεις ασφαλείας	77
1.3	Λεζάντες εικονογραμμάτων	77
1.4	Παραδοτέα	88
1.5	Τεχνικά στοιχεία	88
2	Χειρισμός	89
2.2	Σύνδεση της συσκευής στο δίκτυο ρεύματος	89
2.3	Ενεργοποίηση συσκευής	89
2.4	Καταστροφή χαρτιού	90
2.10	Καταστροφή καρτών	92
3	Συντήρηση/Αντιμετώπιση βλαβών	93
3.1	Άδειασμα προϊόντων κοπής	93
3.3	Δοχείο/καπάκι ανοιχτό	93
3.4	Υπερθέρμανση	94
3.6	Συσσώρευση χαρτιού χειροκίνητης εισαγωγής	94
3.8	Συσσώρευση χαρτιού αυτόματης εισαγωγής	95
3.15	Καθαρισμός συσκευής	97

1.1 Ενδεειγμένη χρήση, παροχές εγγύησης

Ο καταστροφέας εγγράφων προορίζεται για την καταστροφή χαρτιών.

Ανάλογα με την έκδοση του μοντέλου, καταστρέφει επίσης και τα παρακάτω υλικά σε μικρές ποσότητες:

- CD/DVD, χρωστικές και πιστωτικές κάρτες (βλέπε Τεχνικά Στοιχεία).
- συνδετήρες και σύρματα συρραπτικών στις συνηθισμένες ποσότητες που χρησιμοποιούνται σε έγγραφα (εξαιρέση: συσκευές της κατηγορίας ασφαλείας P6 και P7).

Η φθορά, οι ζημιές από ακατάλληλη χρήση καθώς και οι επεμβάσεις από τρίτους δεν περιλαμβάνονται στις παροχές της εγγύησης ούτε καλύπτονται από εγγύηση.

Ο καταστροφέας εγγράφων έχει σχεδιαστεί για ιδιωτική χρήση και κανονικές συνθήκες γραφείου.

Σχετικά με την απόδοση σε φύλλα που αναφέρεται στα παρακάτω τεχνικά στοιχεία ισχύουν οι ακόλουθες προϋποθέσεις πλαισίου:

Μέγιστο πλήθος φύλλων, που κόβεται σε μία διέλευση υπό τις ακόλουθες προϋποθέσεις: Καινούργιοι ενδεχ. λιπασμένοι κύλινδροι κοπής, ψυχρός κινητήρας, τροφοδοσία ρεύματος με ονομαστική τάση και ονομαστική συχνότητα (230 V/50 Hz, 120 V/60 Hz).

Τυχόν αποκλίσεις μπορεί να οδηγήσουν σε μειωμένη απόδοση σε φύλλα και σε αυξημένους θορύβους λειτουργίας. Τα φύλλα τροφοδοτούνται κεντρικά και κατά μήκος κάτω από 90°. Ανάλογα με τις ιδιότητες του χαρτιού και την τροφοδοσία, η απόδοση σε φύλλα μπορεί και να διαφέρει.

1.2 Υποδείξεις ασφαλείας

- Ελέγξτε αν η τάση και η συχνότητα του δικτύου ρεύματος συμφωνούν με τα στοιχεία στην πινακίδα τύπου.
- Υποδείξεις ασφαλείας
- Η συσκευή δεν επιτρέπεται να τοποθετείται κοντά σε πηγές θερμότητας!
- Αποθηκεύετε, μεταφέρετε και λειτουργείτε τη συσκευή μόνο σε όρθια θέση!
- Χρησιμοποιείτε στη συσκευή μόνο υγρά και αέρια που πληρούν τις οδηγίες DAHLE!
- Η συσκευή δεν επιτρέπεται να ανοίγεται!
- Η λειτουργία της συσκευής επιτρέπεται μόνο σε κλειστούς χώρους, με θερμοκρασία από 10°C έως 25°C (50°F έως 77°F) και μη συμπυκνούμενη υγρασία αέρα από 15% έως 94%!
- Πρέπει να διασφαλίζεται η ασφάλεια βραχυκυκλώματος της κτιριακής εγκατάστασης: έως 16 A (H.Π.Α. έως 20 A).

- Η συσκευή δεν πρέπει να λειτουργεί άδεια!
- Η συσκευή δεν προορίζεται για χρήση από άτομα (συμπεριλαμβανομένων παιδιών) με περιορισμένες φυσικές, αισθητηριακές ή πνευματικές ικανότητες ή ελλιπή εμπειρία και γνώσεις, εκτός αν εργάζονται υπό επίτηρηση ή έχουν λάβει λεπτομερείς οδηγίες σχετικά με τη χρήση της συσκευής από άτομο υπεύθυνο για την ασφάλεια.



Ο καταστροφέας εγγράφων πρέπει να απορρίπτεται σωστά και με περιβαλλοντικά ορθό τρόπο σε εξουσιοδοτημένο κέντρο συλλογής. Μην ρίχνετε μέρη του καταστροφέα εγγράφων ή της συσκευασίας στα οικιακά απορρίμματα.

1.3 Λεζάντες εικονογραμμάτων



Σημαντική πληροφορία



Διαβάστε τις πληροφορίες χρήστη και τις υποδείξεις ασφαλείας



ΠΡΟΣΟΧΗ



ΠΡΟΣΟΧΗ! Κίνδυνος ηλεκτροπληξίας.



ΠΡΟΣΟΧΗ, κινούμενα μέρη



ΠΡΟΣΟΧΗ, αιχμηρές άκρες



Δεν επιτρέπεται η χρήση κοντά σε διαβρωτικά υλικά.



Η συσκευή πρέπει να τοποθετείται με στατική ασφάλεια στο δάπεδο, σε απόσταση 100 mm από τον τοίχο και να αποφεύγεται η συσσώρευση θερμότητας. Να χρησιμοποιούνται τα φρένα ακινητοποίησης (ανάλογα με τον τύπο)



Δεν επιτρέπεται η χρήση κοντά σε εύφλεκτα υγρά ή αέρια.



Αυτόματη εκκίνηση λειτουργίας



Δεν επιτρέπεται η έκθεση σε υγρασία



Αυτός ο καταστροφέας εγγράφων δεν προορίζεται για χρήση από παιδιά (το προϊόν δεν είναι παιχνίδι).



Μην αγγίζετε με τα χέρια την τροφοδοσία χαρτιού.



Μην αγγίζετε με μέρη της ενδυμασίας την τροφοδοσία χαρτιού!



Τα μαλλιά σας δεν πρέπει να αγγίζουν την τροφοδοσία χαρτιού!



Κρατάτε μακριά τυχόν δοχεία ψεκασμού!



Οι συνδετήρες γραφείου και συρραπτικών πρέπει να αφαιρούνται πριν από τη διαδικασία καταστροφής!



Μην εισάγετε δισκέτες!





Πριν από εργασίες συντήρησης αποσυνδέετε τον καταστροφέα εγγράφων από την τροφοδοσία ρεύματος!





Τεχνικά στοιχεία - Με την επιφύλαξη του δικαιώματος τεχνικών αλλαγών!

- 

Ένταση ήχου σε άδεια λειτουργία
- 

Ταχύτητα εισαγωγής
- 

Κοπή χαρτιού σε τεμάχια
- 

Κοπή καρτών σε τεμάχια
- 

Βάρος
- 

Το φως δικτύου ρεύματος χρησιμεύει ως διάταξη αποσύνδεσης της τροφοδοσίας ρεύματος.
- 

Η πρίζα πρέπει να είναι εύκολα προσβάσιμη ανά πάσα στιγμή!
- 

Χειρισμός
- 

Καταστροφέας εγγράφων σε λειτουργική ετοιμότητα
- 

Καταστροφέας εγγράφων σε λειτουργία
- 

Αυτόματη απενεργοποίηση!
- 

Κατά την παρατεταμένη λειτουργία και/ή υπερφόρτωση ο καταστροφέας εγγράφων μεταβαίνει αυτόματα σε λειτουργία ψύξης.
- 

Υποδείξεις συντήρησης / Αντιμετώπιση βλαβών
- 

Κάδος γεμάτος
- 

Πιθανές διαταραχές
- 

Αυτόματη απενεργοποίηση με ανοιχτό περίβλημα



انتبه!

قم بقراءة دليل الاستعمال وتعليمات الأمان بعناية قبل بدء تشغيل ماكينة تقطيع الورق. لا بد من تطبيق هذه التعليمات. احتفظ بدليل الاستعمال لاستخدامه لاحقاً.

ماكينة فرم المستندات مخصصة لإتلاف الورق. تبعاً لنوع الموديل يمكن أيضاً إتلاف كمية قليلة من المواد التالية:
- الأقراص المضغوطة/أقراص DVD وبطاقات صرف الشيكات وبطاقات الائتمان (انظر البيانات التقنية).
- دبابيس المكتب ومشابك الورق التقليدية الموجودة في الوثائق الورقية (باستثناء: الأجهزة بمستوى الأمان P6 و P7).

المحتويات

79	1	معلومات هامة.
79	1.1	الاستخدام المطابق للتعليمات، الضمان
80	1.2	تعليمات السلامة
80	1.3	رموز الرسم التوضيحي.
88	1.4	المحتويات المُوَدَّة
88	1.5	المواصفات التقنية
89	2	الاستخدام
89	2.2	توصيل الجهاز بمأخذ التيار الكهربائي
89	2.3	تشغيل الجهاز.
90	2.4	إتلاف الورق
92	2.10	إتلافو البطاقات.
93	3	الصيانة / إزالة الأعطال.
93	3.1	تفريغ القصاصات
93	3.3	الحاوية / الغطاء مفتوح.
94	3.4	ارتفاع في درجة الحرارة.
94	3.6	تكسد الورق في وحدة التغذية اليدوية
95	3.8	تكسد الورق في وحدة التغذية الأوتوماتيكية
97	3.15	تنظيف الجهاز

فيما يتعلق بسعة الورق المنصوص عليها في البيانات التقنية تطبق الشروط العامة التالية:
الحد الأقصى لعدد الأوراق المقطوعة دفعة واحدة تحت الشروط التالية: إسطوانات قطع جديدة، ومزيتة إذا لزم الأمر، محرك بارد، وتغذية كهربية بجهد اسمي وتردد اسمي (٢٣٠ فولت / ٥٠ هرتز، ١٢٠ فولت / ٦٠ هرتز).
الانحرافات يمكن أن تؤدي إلى انخفاض معدل سعة الورق وزيادة الضوضاء أثناء التشغيل. يتم تغذية الأوراق في المنتصف وبالطول في اتجاه ٩٠ درجة. قد تختلف سعة الورق أيضاً اعتماداً على خصائص الورق والتغذية.

1.2 تعليمات الأمان

- تحقق من توافق الجهد وتردد الطاقة بشبكة إمداد الطاقة لديك مع المعلومات الواردة على لوحة البيانات.
- لا تضع الماكينة بالقرب من مصدر حرارة!
- لا تُخزّن الماكينة ولا تُنقل ولا تُشغل إلا وهي قائمة في وضع رأسي!
- لا تُستخدم في الماكينة إلا السوائل والغازات التي تتفق مع توجيهات شركة DAHLE!
- لا تقم بفتح الماكينة!
- لا يجب تشغيل الجهاز في الأماكن المغلقة إلا ضمن درجات حرارة تتراوح ما بين ١٠ وحتى ٢٥ درجة مئوية (٥٠ إلى ٧٧ درجة فهرنهايت) وفي رطوبة غير مكثفة تتراوح ما بين ١٥٪ إلى ٩٤٪!

- يجب الحماية من قصر الدائرة بتركيبات البناء: الحد الأقصى ١٦ أمبير (٢٠ أمبير بحد أقصى في الولايات المتحدة).
- لا يتم تشغيل الماكينة على سرعة التباطؤ!
- الجهاز غير مخصص للاستخدام بواسطة أشخاص (هما في ذلك الأطفال) ممن لديهم ضعف في القدرات الجسدية أو الحسية أو العقلية أو ممن لديهم نقص خبرة ومعرفة إلا تحت إشراف أو بتلقي تعليمات تفصيلية عن استخدام الجهاز من قِبَل شخص يكون مسئولاً عن السلامة.

تخلص من ماكينة تقطيع الورق بطريقة سليمة وصادقة للبيئة بإحدى نقاط التجميع المعتمدة. لا تضع أي جزء من أجزاء ماكينة تقطيع الورق أو تغليفها في القمامة المنزلية.



1.3 رموز الرسم التوضيحي

معلومات هامة		توضع ماكينة تقطيع الورق في وضع مستقر على الأرضية وعلى مسافة ١٠٠ ملم من الحائط ∞ تجنب الحرارة المتخلفة.		لا تلمس مغذي الورق بيديك.	
اقرأ معلومات المستخدم / تعليمات الأمان		يُضغَط على فرامل التثبيت (متعلق بالنوع)		لا تلمس مغذي الورق بقطع من الملابس.	
تنبيه / احترس		لا تُستخدم بالقرب من سوائل أو غازات سريعة الاشتعال.		لا تلمس مغذي الورق بيديك.	
انتباه! خطر حدوث صدمة كهربائية.		يتم التشغيل أوتوماتيكيًا		أبعدها عن علب الرذاذ!	
تنبيه الأجزاء المتحركة		لا تُعرَّض للبلل		يجب إزالة مشابك ودبابيس الورق قبل إجراء عملية تقطيع الورق!	
تنبيه ، حواف حادة		ماكينة تقطيع الورق هذه غير مخصصة لاستخدام الأطفال (لا يعتبر المنتج لعبة).		لا تقم بإدخال الأقراص!	
لا تُستخدم بالقرب من مواد كاوية.		قبل القيام بأعمال الصيانة يجب فصل ماكينة تقطيع الورق عن إمداد الطاقة!			

<p>البيانات التقنية - يُحتفظ بالحق في عمل تغييرات تقنية!</p>		<p>يجب أن يكون مقبس الطاقة في موضع يسهل الوصول إليه في أي وقت!</p>		<p>تعليمات الصيانة / إصلاح الأعطال</p>	
<p>مستوى صوت التشغيل على سرعة التباطؤ</p>		<p>الاستعمال</p>		<p>الوعاء ممتلئ</p>	
<p>سرعة التغذية</p>		<p>ماكينة تقطيع الورق في وضع الاستعداد</p>		<p>حالات الخلل المحتملة</p>	
<p>تقطيع الورق على شكل جزيئات صغيرة</p>		<p>ماكينة تقطيع الورق قيد التشغيل</p>		<p>الفصل الأوتوماتيكي عند التشغيل عند فتح العلبة</p>	
<p>قطع البطاقات البلاستيكية في شكل جزيئات صغيرة</p>		<p>الفصل الأوتوماتيكي!</p>			
<p>الوزن</p>		<p>عند التشغيل لفترات طويلة و/أو التحميل الزائد تفصل ماكينة قطع الأوراق أوتوماتيكيًا للتبريد.</p>			
<p>يُستخدم قابس التيار كتهجيزة قطع لإمداد الطاقة.</p>					



注意!

ご使用前に、本製品の取扱説明書に記載されている使い方や安全上の注意をよくお読みください。



安全上の指示を必ず守ってご使用ください。取扱説明書はいつでも読めるように保管しておいてください

目次

1	重要事項	82
1.1	正しい使用法 製品の保証について	82
1.2	安全上の注意	83
1.3	ピクトグラムの説明	83
1.4	製品の内容	88
1.5	技術仕様	88
2	操作	89
2.2	装置を電源に接続する	89
2.3	装置のスイッチを入れる	89
2.4	用紙の裁断	90
2.10	カードの裁断	92
3	メンテナンス / トラブルシューティング	93
3.1	ダストボックスを空にする	93
3.3	ダストボックス/カバーが開いている	93
3.4	装置の過熱	94
3.6	手動フィードの紙詰まり	94
3.8	オートフィードの紙詰まり	95
3.15	お手入れ方法	97

このシュレッダーは紙を細断するためにつくられています。機種によっては、次のものを少量ずつ細断できるタイプもございます:

- CD/DVD、キャッシュカード、クレジットカード (技術仕様をご確認ください)。
- 一般的な文書類に使用される、市販のホチキス(セキュリティレベルP6およびP7は除く)。

指示に従わなかったり、用途以外のものを投入したことや生じた故障や損害について、当社は一切の責任を負いません。また、これらの故障や損害は当社保証の対象外となります。

本シュレッダーは、個人使用および一般的な事務での使用向けに設計されています。技術仕様に記載の処理能力に応じて、以下の条件が適用されます。

一回に挿入できる枚数は、以下の条件で定義したものです。新品もしくはオイルを塗布したローラー、エンジン冷間状態、公称電圧および公称周波数 (230V/50Hz; 120V/60Hz)

での電源供給。上記以外の条件で使用した場合は、挿入できる枚数が減ったり音が大きくなる場合があります。用紙は中央から縦方向に、90度以上曲げずに挿入。用紙の性質や入れ方によっては、処理内容に変化が生じる可能性があります。

1.2 安全に関するご注意

- ご使用電源の電圧および周波数が、本製品形式表示板の表記と一致することをご確認ください。
- 本機を熱源のそばに置かないでください。
- 本機は決して倒さず、縦にして保管や移動をしてください。
- ダーレ社の純正シュレッダーオイル、ガス以外は使用しないでください。
- 本体を決して開けないでください。
- 本機は温度 10°C~25°C (50°F~77°F) の閉めきった部屋で使用してください。また、湿度は15%~94%以内を保ち、結露しないように注意してください。
- 建物の配線設備の短絡保護装置が正常に作動することをご確認ください (最大16 A、米国では20A)。
- 本機を空回りさせないでください。
- 身体上の理由または知覚・精神上の理由から操作に困難を伴う方 (お子様も含む) や、装置の操作に関する経験と知識が不十分な方は、本機を単独でご使用にならないでください。上記の方が本機を扱う際は、安全面で責任を持てる方が付き添って操作し、操作について十分な指導を行うことが必須要件となります。



シュレッダーを廃棄する際は分別方法および環境に配慮し、自治体の指示に従ってください。シュレッダーのパーツや梱包材は、一般ゴミとして廃棄しないでください

1.3 ピクトグラムの説明



重要事項



取扱説明書/安全に関する注意事項をお読みください



注意



注意! 感電の危険があります。



注意、可動部品



注意、鋭いエッジ



本製品を錆びつく恐れのある物質の近くで使用しないでください。



本機は床にしっかり安定させ、壁面から 100 mm 離して設置してください。また、本体内部が過熱しないよう注意し、必ずストッパーを使用してください (機種により異なる)



可燃性の液体やガスの近くでは使わないでください。



オートスタート



湿度の高い場所に放置しないでください。



本製品は、お子様向けのものではありません。(シュレッダーで遊ばないこと)。



用紙投入口に手を触れないでください。



用紙投入口に服が巻き込まれないようご注意ください。



用紙投入口に髪の毛が巻き込まれないようご注意ください。



スプレー缶を近づけないでください。



用紙クリップやホチキスはシュレッダーにかける前に外してください。

















フロッピーディスクは本機で裁断できません。



メンテナンスを行う前に、必ず電源プラグを抜いてください。

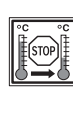

技術仕様 - 内容は予告なく変更される場合があります

- | | | |
|--|--|--|
|  <p>空回り時の騒音レベル</p> |  <p>電源プラグはいつでもすぐに取り差しできるようにしておいてください。</p> |  <p>メンテナンスについて /
トラブルの解消</p> |
|  <p>細断速度</p> |  <p>操作</p> |  <p>ダストボックスが満杯
です</p> |
|  <p>用紙 - クロスカット</p> |  <p>スタンバイ中</p> |  <p>故障かなと思ったら</p> |
|  <p>カード - クロスカット</p> |  <p>作動中</p> |  <p>本機が開いたままになっ
た場合のオートオフ機能</p> |
|  <p>質量</p> |  <p>オートオフ</p> | |
|  <p>プラグで電源の入/切を
行います</p> |  <p>長時間作動したり過負
荷の状態になると、自動
的にオフになって本体を
冷まします。</p> | |

CN 使用说明

1.1 预定用途， 保修



注意!

使用碎纸机之前，请仔细阅读本操作说明书和安全指南。

必须遵守本指南的内容！

妥善保管本操作说明书，以备将来使用。



目录

1	重要信息	85
1.1	常规使用， 保修	85
1.2	安全指南	86
1.3	图形符号图例	86
1.4	供货范围	88
1.5	技术数据	88
2	操作	89
2.2	将设备与电源相连	89
2.3	接通设备	89
2.4	纸张粉碎	90
2.10	卡片粉碎	92
3	保养/故障排除	93
3.1	清空粉碎物	93
3.3	容器/盖板呈打开状态	93
3.4	加热	94
3.6	手动送纸塞纸	94
3.8	自动送纸塞纸	95
3.15	清洁设备	97

本碎纸机用于粉碎纸张。

根据机器型号的不同可以粉碎少量以下物品：

- CD/DVD、支票和信用卡（详见技术数据）。
- 在纸质文档中以及通常使用的订书钉及回形针（例外情况：P6 和 P7 安全等级设备）。

由于不恰当使用或从第三方购买造成的磨损及损坏不属于保修或保证范围。

碎纸机设计用于在私人场所和正常办公环境下运行。

根据技术数据页数容量的规定，适用下列条件：

在下列条件下单次切碎的最大纸张数量：加油润滑过的新碎纸辊（若有必要）、冷电动机、具有额定电压和频率（230 伏特/50 赫兹；120 伏特/60 赫兹）。偏差可能导致较低的纸张容量，并在操作期间增加噪音。纸张应在 90°C 下纵向置中插入。纸张容量可能因为纸张特性与入口不同而变化。

1.2 安全指南

















- 请保证电源x的电压和频率与铭牌上的指示相符。
- 不要将本设备置于热源附近！
- 本设备只能以直立状态放置、运输及运行！
- 本设备上只能使用符合 DAHLE 规定的液体或气体！
- 不要打开本设备！
- 本设备只能在温度为 10° C 至 25° C (华氏 50° F 到 77° F) 且非凝湿度为 15% 至 94% 的室内使用！
- 确保房屋安装的短路保险丝工作正常：最大电流 16 安 (美国最大电流 20 安) 。
- 不要让设备空转！
- 身体、知觉或精神有障碍以及缺乏设备操作经验知识的人士 (包括孩子) 不得操作该设备。正常人只有在安全人员监督下，或得到全面设备使用指导的情况下才可使用设备。



以专业环保方式报废碎纸机，将垃圾送到认可的回收站处置。请不要将碎纸机的部件或包装与生活垃圾一同处置。

1.3 图形符号

- | | | |
|---|--|---|
|  重要信息 |  将本设备平稳地直立在地面上，离墙 100 毫米，避免操作紧急制动时，热量积聚 (取决于型号) |  请不要让衣服接触进纸入口！ |
|  阅读使用者信息/安全指南 |  使用时请远离易燃易爆液体及气体。 |  请不要让毛发接触进纸入口！ |
|  注意 |  自动开机 |  远离喷雾罐！ |
|  注意！有电击危险。 |  不要暴露在潮湿的环境中 |  请在销毁文件前去掉回形针和钉书针！ |
|  注意，活动部件 |  不要让儿童使用本碎纸机 (本产品不是玩具) 。 |  未插入软盘！ |
|  注意，锐利的边缘 |  请不要用手接触进纸入口。 |  维修碎纸机前要断电！ |
|  使用时请远离腐蚀性物品。 | |  技术数据 — 保留技术变更的权利！ |

- | | | | | | |
|--|-------------|---|----------------------------|---|-------------|
|  | 空转时的机器噪音 |  | 电源插座应随时方便使用！ |  | 维护指南 / 故障排除 |
|  | 卷入速度 |  | 操作 |  | 容器已满 |
|  | 纸张碎粒 |  | 准备状态下的碎纸机 |  | 可能的故障 |
|  | 卡片碎粒 |  | 使用状态下的碎纸机 |  | 打开机壳时会自动关机 |
|  | 重量 |  | 自动关机！ | | |
|  | 电源插头用作断电装置！ |  | 在延长操作时间和/或过载时，碎纸机会自动关机以降温。 | | |

1.4

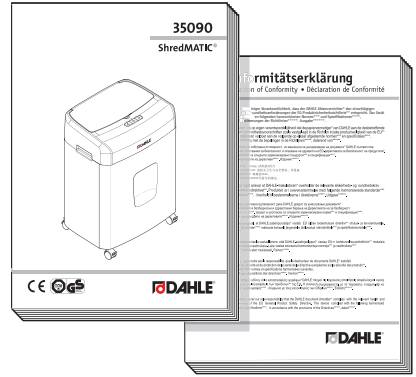
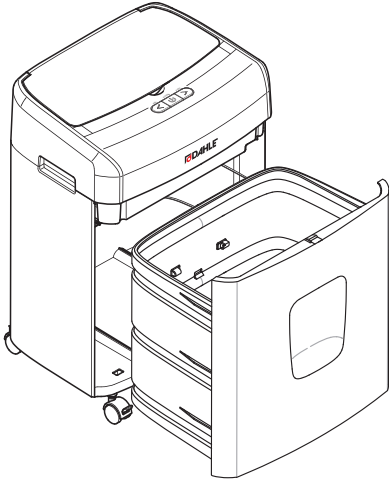

1.5

A4
70 g/m²
max. 90

A4
80 g/m²
max. 90

US letter
20 lb
max. 90

1,8m/min
6ft.

A4
70 g/m²
max. 10

A4
80 g/m²
max. 10

US letter
20 lb
max. 10

220-240VAC / 50-60 Hz
110-120VAC / 50-60 Hz

DIN 66399
P-4/F-1

4x12mm
3/16"x1/2"

DIN 66399
T-4/E-3

max 1

≤62dB (A)

9 kg
19.8 lbs

23l / 6.5/8 gal

501mm
20"

263mm
10 1/3"

367mm
14 4/9"

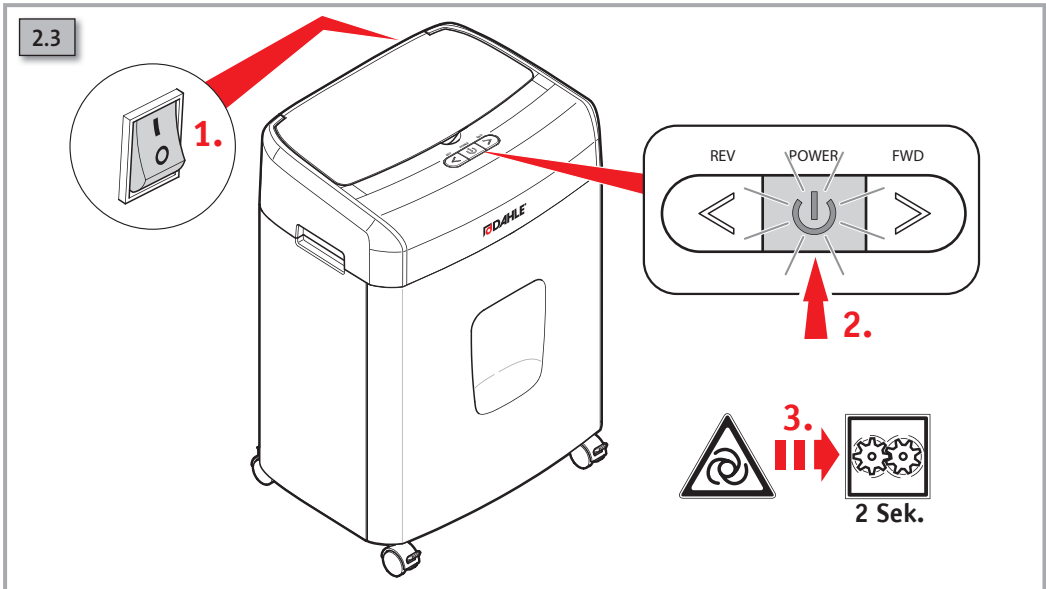
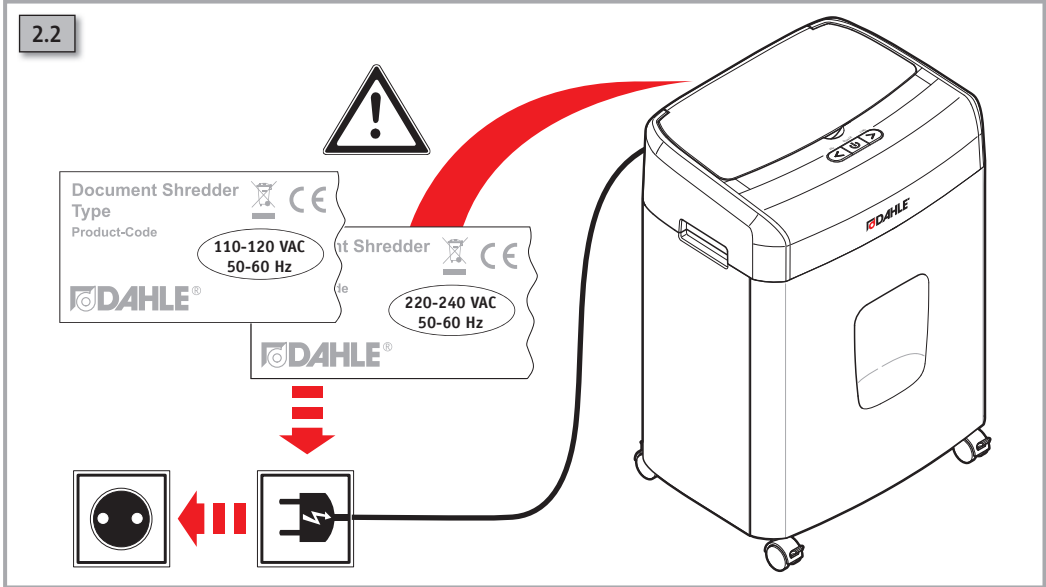

2



2.4



2.5

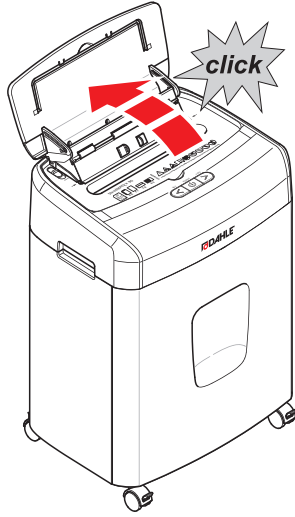
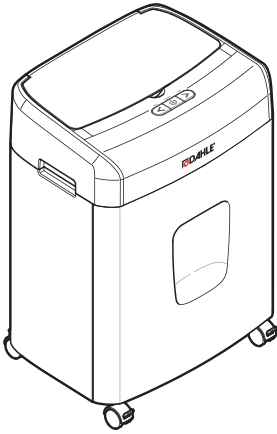

O.K.

2.6

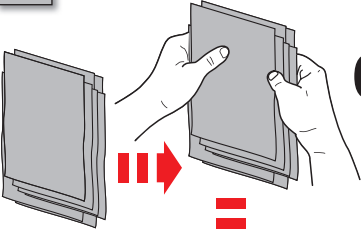

O.K.

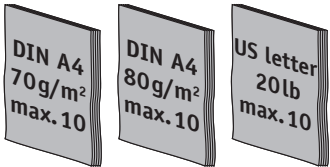

O.K.

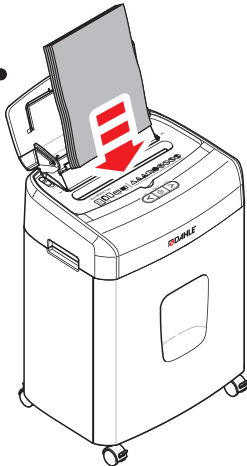

2.7

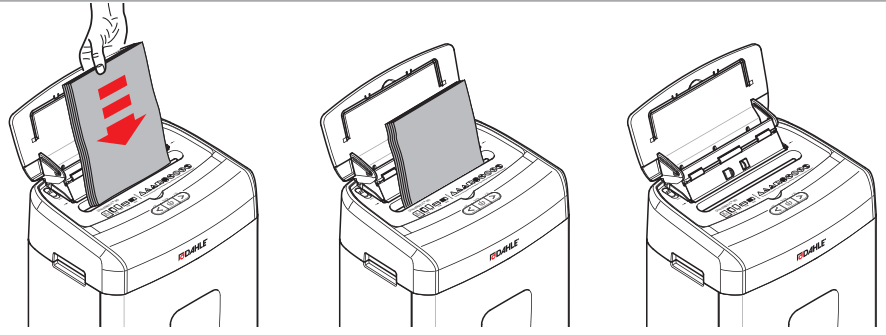

2.8

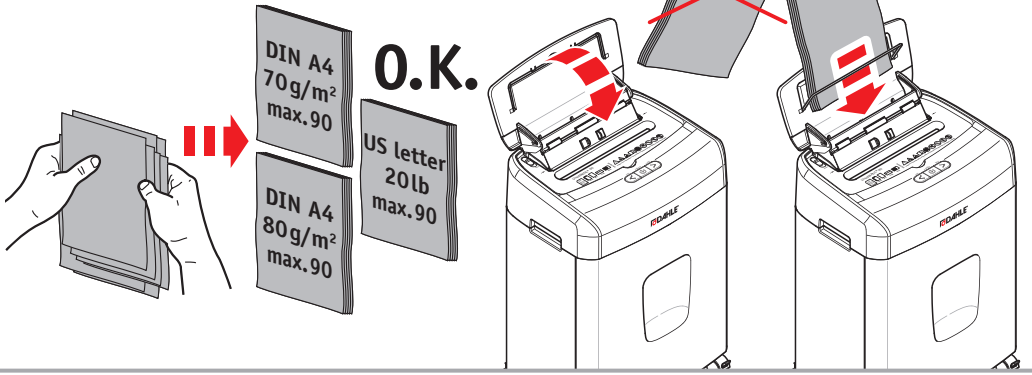

2.9

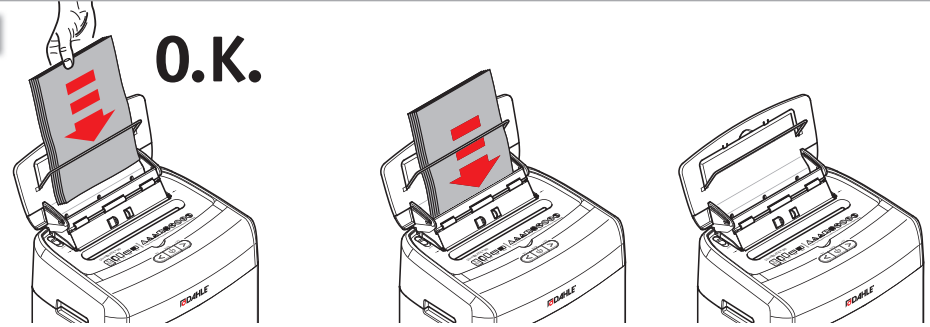

O.K.



2



2.10



2.11

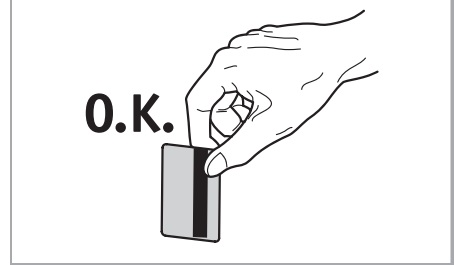
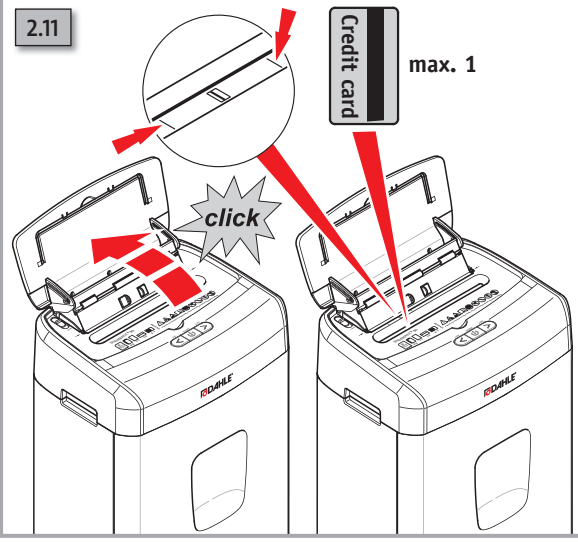

2.12

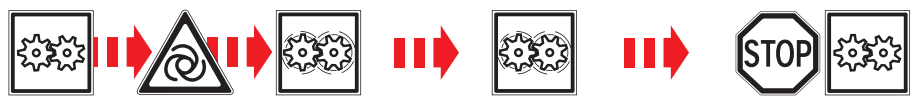
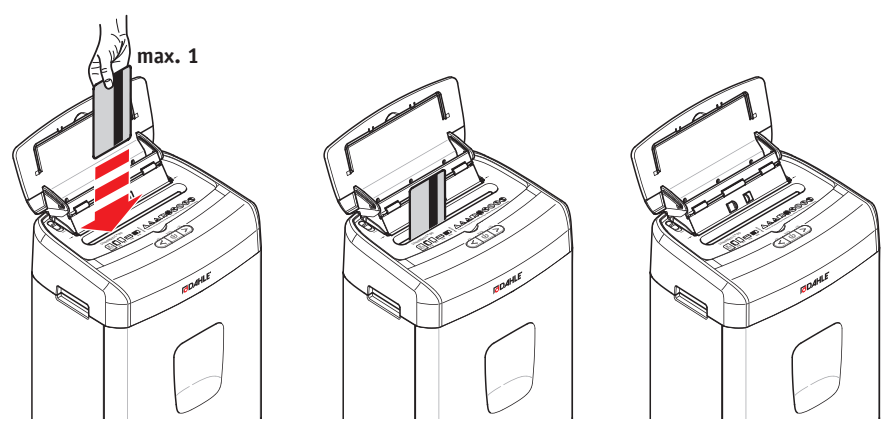



3.1



~~O.K.~~

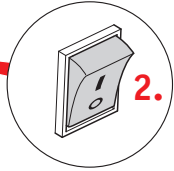
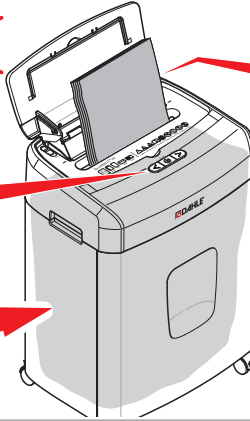
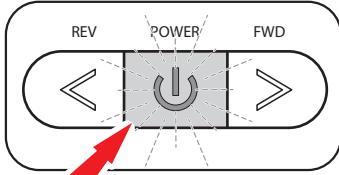

3.2

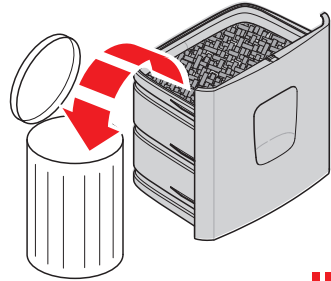
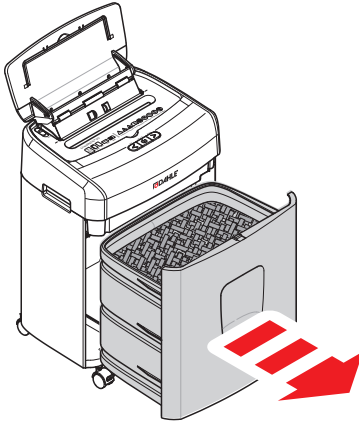

2.2

3.3

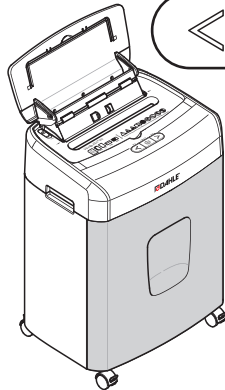
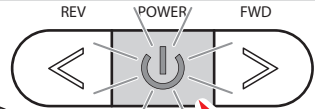
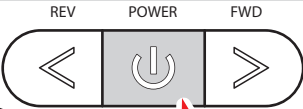

3.4

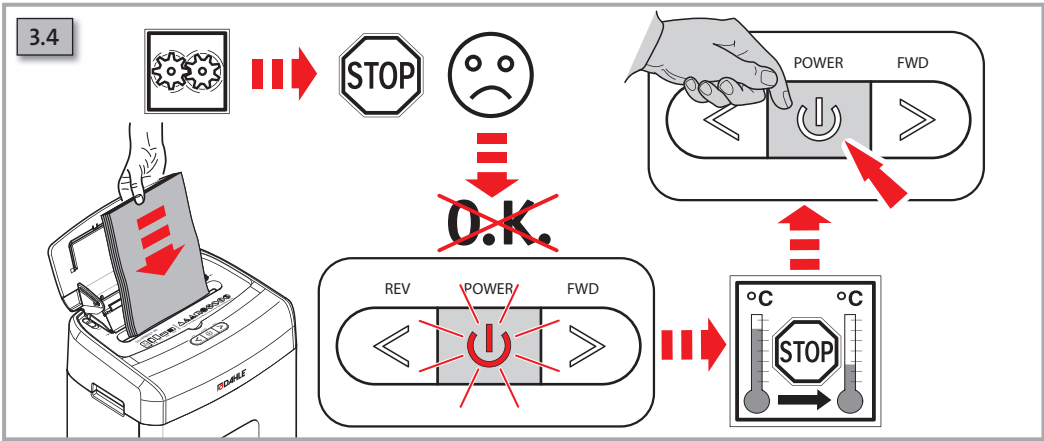

O.K.



POWER FWD

REV POWER FWD

°C °C

STOP

3.5

Type		
	ON	OFF
35090	25 min*	50 min*

* → www.novus-dahle.com

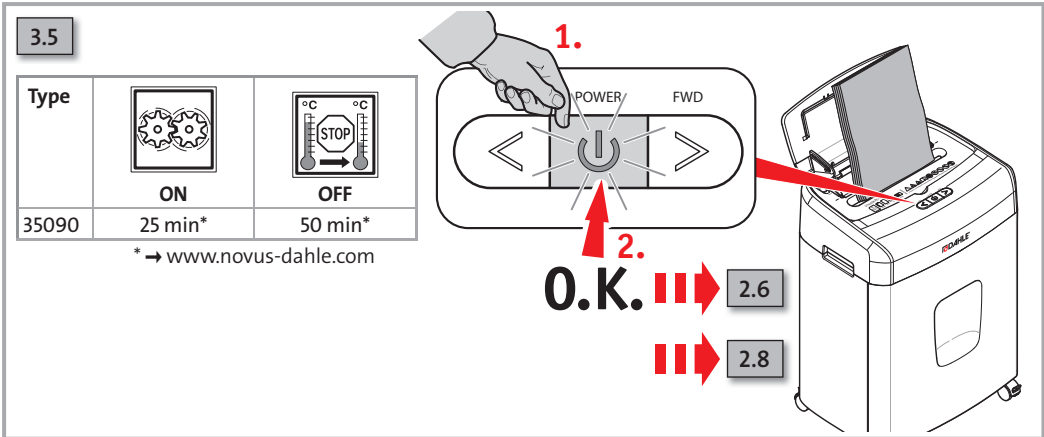

1.

POWER FWD

2.

O.K.

2.6

2.8

3.6

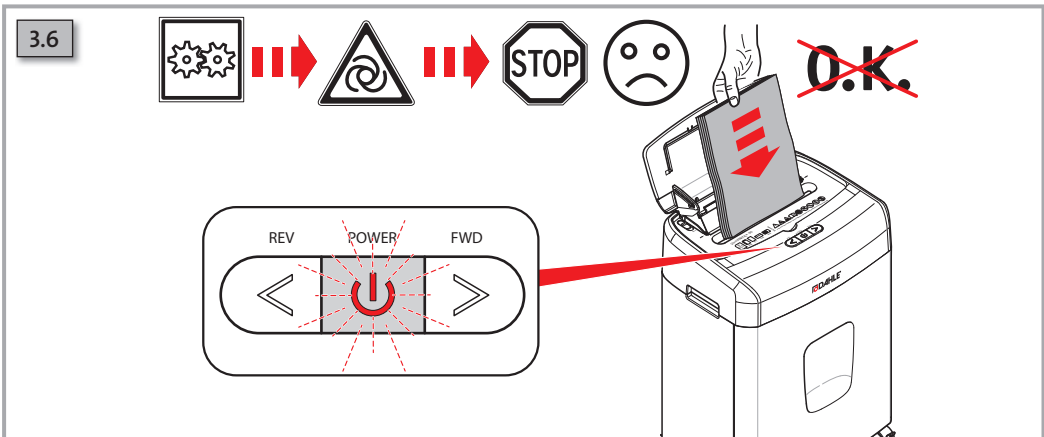

O.K.

REV POWER FWD



3.7

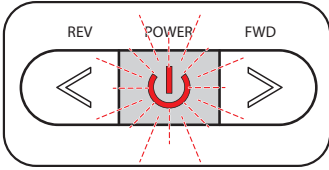

1.

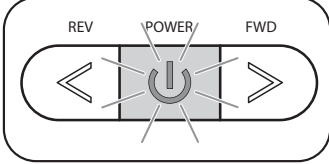
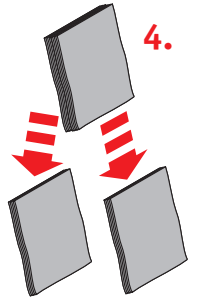
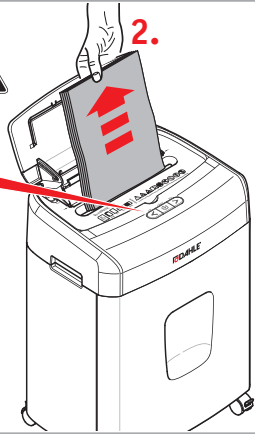

3.

2.6

3.8



~~O.K.~~

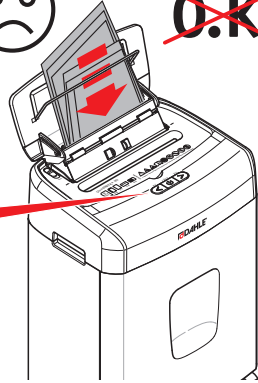
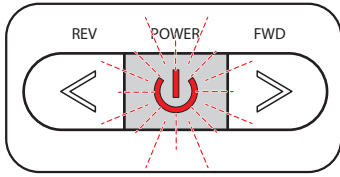

3.9

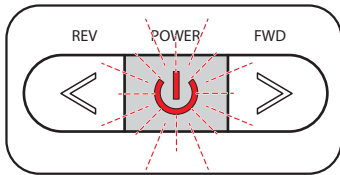

1.



2.

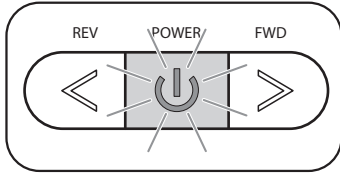
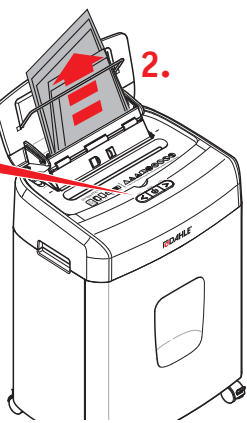

3.

3



3.10



~~O.K.~~

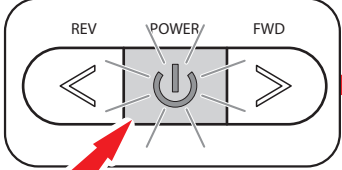

1.

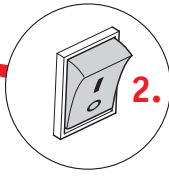
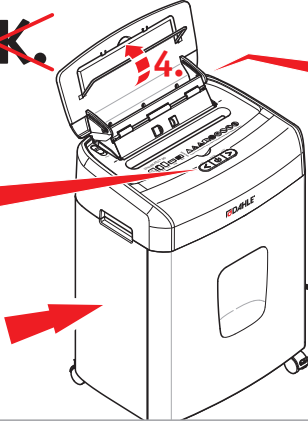

2.



3.

3.11

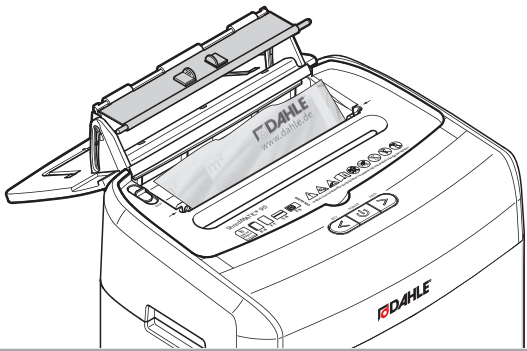
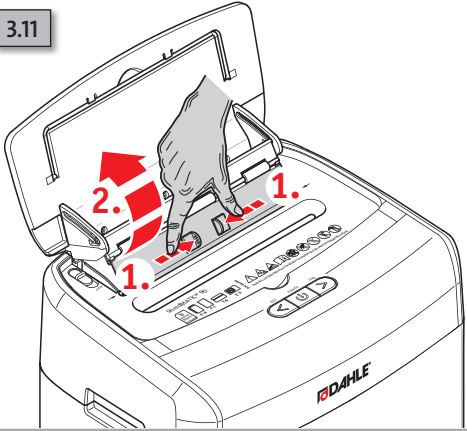

3.12

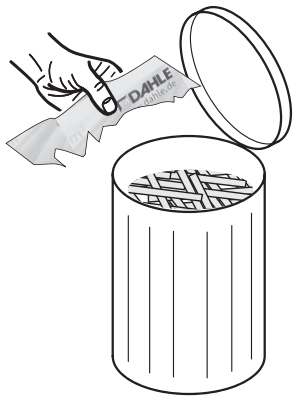
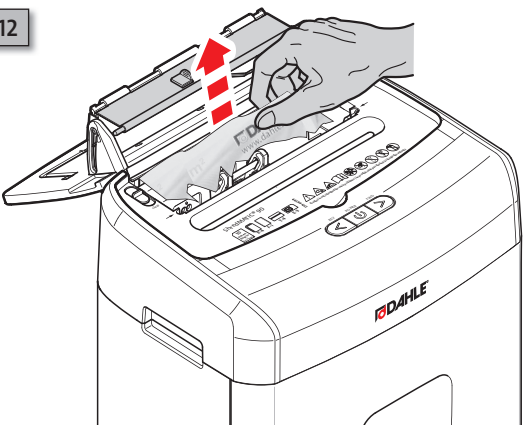

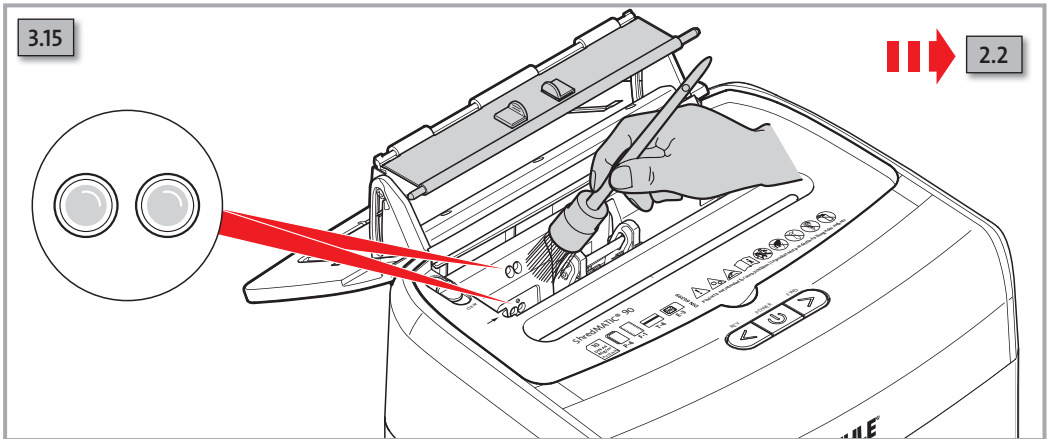
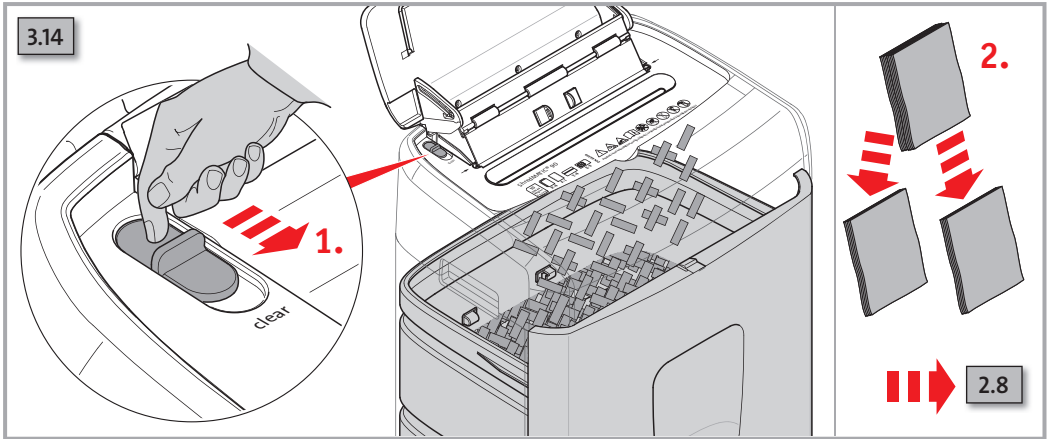
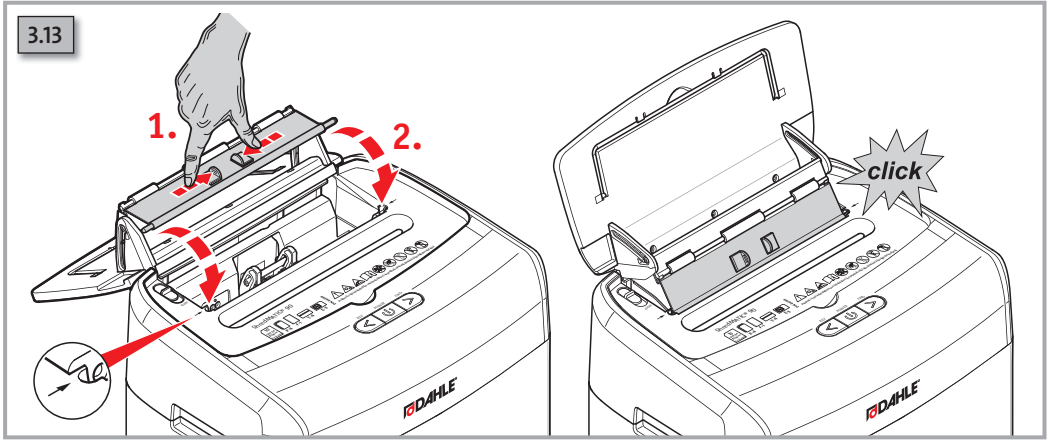

3



3.16

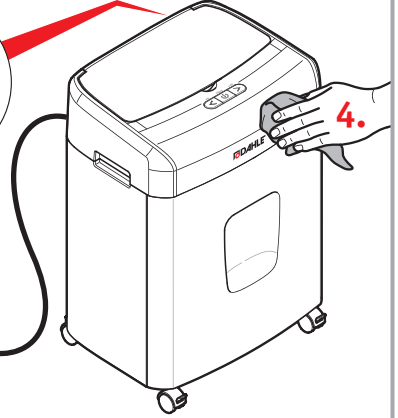
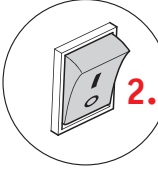
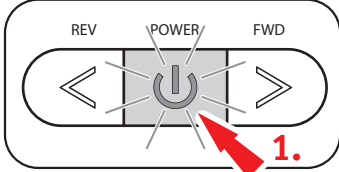

Headquarters:

Novus Dahle GmbH
Breslauer Straße 34 - 38
DE-49808 Lingen (Ems)

Service contact:

Novus Dahle GmbH
Nikolaus-A.-Otto-Straße 11
96472 Rödental · Germany
Tel.: +49 (0) 9563 75299-0
Fax: +49 (0) 9563 75299-333
info@novus-dahle.com
www.novus-dahle.com